



Theses and Dissertations

---

2010-10-13

## Design Principles and Preliminary Actuation Approaches for Novel Multiple-Layer Lamina Emergent Mechanisms

Paul Shumway Gollnick  
*Brigham Young University - Provo*

Follow this and additional works at: <https://scholarsarchive.byu.edu/etd>



Part of the [Mechanical Engineering Commons](#)

---

### BYU ScholarsArchive Citation

Gollnick, Paul Shumway, "Design Principles and Preliminary Actuation Approaches for Novel Multiple-Layer Lamina Emergent Mechanisms" (2010). *Theses and Dissertations*. 2279.  
<https://scholarsarchive.byu.edu/etd/2279>

This Thesis is brought to you for free and open access by BYU ScholarsArchive. It has been accepted for inclusion in Theses and Dissertations by an authorized administrator of BYU ScholarsArchive. For more information, please contact [scholarsarchive@byu.edu](mailto:scholarsarchive@byu.edu), [ellen\\_amatangelo@byu.edu](mailto:ellen_amatangelo@byu.edu).

Design Principles and Preliminary Actuation Approaches  
for Novel Multiple-Layer Lamina Emergent Mechanisms

Paul S. Gollnick

A thesis submitted to the faculty of  
Brigham Young University  
in partial fulfillment of the requirements for the degree of  
Master of Science

Spencer P. Magleby, Chair  
Larry L. Howell  
Scott L. Thomson

Department of Mechanical Engineering  
Brigham Young University  
December 2010

Copyright © 2010 Paul S. Gollnick  
All Rights Reserved



## ABSTRACT

Design Principles and Preliminary Actuation Approaches  
for Novel Multiple-Layer Lamina Emergent Mechanisms

Paul S. Gollnick

Department of Mechanical Engineering

Master of Science

Multiple-layer Lamina Emergent Mechanisms (MLEMs) are mechanisms made from multiple sheets (lamina) of material with motion that emerges out of the fabrication plane. This study has shown that understanding how layers are used in existing products and in nature provides insight into how MLEMs can also use layers to achieve certain tasks. The multi-layered nature of MLEMs and the interactions between these layers are what enhance the capabilities of MLEMs and allow them to better meet design objectives. Layer separation is one objective for which MLEMs are well-suited. Layer separation can have a variety of applications and there are a number of different ways to design a MLEM to achieve this objective.

Single-layer LEM and MLEM designs could greatly benefit from suitable actuation techniques; those that are consistent with the advantages of these mechanisms and could be incorporated into their design. This work presents shape memory alloys, piezoelectrics and dielectric elastomers as suitable ways of actuating LEMs and MLEMs.

A number of novel MLEMs are presented throughout this thesis.

Keywords: Paul Gollnick, multi-layer, multiple-layer, lamina, emergent, mechanism, lamina emergent mechanism, LEM, MLEM, actuation, layer separation



## ACKNOWLEDGMENTS

First of all, I want to thank God, who has brought me to where I am today. This BYU experience has been truly amazing and I am humbled by the opportunities that God has given me. Where I am today is a result of many small and simple miracles that God has worked in my life. I know the future is bright and I'm looking forward to see where God takes me from here.

Next, I want to thank my family. My mother and father for their unparalleled love and support. Next to God, my parents have done the most to help me get to where I am today. I also thank my immediate and extended family for their love and support.

Third, I want to thank the professors who have taught me so much about mechanical engineering. I want to especially thank my committee: Dr. Magleby, my graduate advisor, for his leadership and guidance, Dr. Howell for giving me the opportunity to be a part of the Compliant Mechanisms Research Group and for all of the lessons he has taught me during this time, and Dr. Thomson, under whom I did my undergraduate research, which helped me decide to pursue a Masters degree in Mechanical Engineering.

Next, I want to thank the other research assistants in the Compliant Mechanisms Research Group, with whom I have worked countless hours and from whom I have learned a lot in the process. I give a special thanks to Larrin Wada for his work in creating many of the figures in this thesis.

I want to thank my other friends who, during these past two years, have also been a great support to me. I am especially grateful for the friendship of my friends Jacob Rice and the Hoyt Family.

I would also like to acknowledge ITW Formex for providing the Formex GK material used to produce the mechanisms presented in this work.

Finally, all of this wouldn't have been possible without the funding provided by the National Science Foundation. I gratefully acknowledge the support from the NSF grant number CMMI 0800606.



## TABLE OF CONTENTS

<b>LIST OF TABLES</b> . . . . .	<b>vi</b>
<b>LIST OF FIGURES</b> . . . . .	<b>viii</b>
<b>Chapter 1 Introduction</b> . . . . .	<b>1</b>
1.1 Introduction . . . . .	1
1.2 Background . . . . .	3
1.2.1 Single-layer LEMs . . . . .	3
1.2.2 Metamorphic Mechanisms . . . . .	4
1.2.3 Pop-up Paper Mechanisms . . . . .	4
1.2.4 Contact-aided Compliant Mechanisms . . . . .	5
1.2.5 Multi-material Compliant Mechanisms . . . . .	6
1.2.6 In-plane Compliant Mechanisms . . . . .	7
1.2.7 Microelectromechanical Systems . . . . .	7
<b>Chapter 2 Multi-layer Systems Inspire MLEMs</b> . . . . .	<b>9</b>
2.1 Mechanical Energy Transfer . . . . .	9
2.2 Thermal Energy Transfer . . . . .	11
2.3 Electrical Energy Transfer . . . . .	12
2.4 Chemical Energy Transfer . . . . .	13
2.5 Light Energy Transfer . . . . .	14
2.6 Energy Transformation . . . . .	14
<b>Chapter 3 Additional Layers Enhance the Capabilities of MLEMs</b> . . . . .	<b>17</b>
3.1 Increased Usable Area . . . . .	18
3.2 Increased Deflection . . . . .	18
3.3 Reduced Footprint . . . . .	19
3.4 Resistance and Energy Storage . . . . .	20
3.5 Contact-aided Interactions Between Layers . . . . .	21
3.6 Biased Motion . . . . .	22
3.7 Increased Actuation Options . . . . .	23
3.8 Enhanced Metamorphic Interactions . . . . .	24
3.9 Bistability . . . . .	26
3.10 MLEM Layer-Separating Mechanisms . . . . .	27
3.10.1 MLEM Layer-separating Conventions . . . . .	28
3.10.2 MLEM Nuremberg Scissors . . . . .	29
3.10.3 MLEM Crank Slider and Parallel-guiding Mechanism . . . . .	29
3.10.4 MLEM Crank-slider and Platform . . . . .	30
<b>Chapter 4 LEM and MLEM Force and Moment Classification</b> . . . . .	<b>33</b>
4.1 Out-of-plane Forces and Moments . . . . .	34
4.2 In-plane Forces and Moments . . . . .	36



<b>Chapter 5</b>	<b>Suitable Actuation Approaches for LEMs</b>	<b>39</b>
5.1	Shape Memory Alloys	39
5.2	Piezoelectrics	42
5.3	Dielectric Elastomers	43
5.4	Summary of the Characteristics of Suitable LEM Actuators	44
<b>Chapter 6</b>	<b>Conclusions and Recommendations</b>	<b>47</b>
6.1	Conclusions	47
6.2	Recommendations	48
<b>REFERENCES</b>		<b>51</b>
<b>Appendix A</b>	<b>Novel Mechanisms Presented in This Work</b>	<b>57</b>

## LIST OF TABLES

3.1	Characteristics of Three Layer-separating MLEMs . . . . .	32
5.1	Suitable LEM Actuator Characteristics . . . . .	45



## LIST OF FIGURES

1.1	Single-layer LEM spring . . . . .	2
1.2	Single-layer LEM crank-slider . . . . .	4
1.3	Metamorphic LEM . . . . .	5
1.4	Pop-up mechanism . . . . .	5
1.5	Compliant contact-aided revolute joint . . . . .	6
1.6	Multi-material clip . . . . .	7
2.1	Layers of a snowboard . . . . .	10
2.2	Layers of a shoe . . . . .	11
2.3	Layers of a frying pan . . . . .	12
2.4	Layers of a membrane switch . . . . .	13
2.5	Layers of the intestine . . . . .	14
2.6	Layers of a cell phone screen . . . . .	15
2.7	Layers of a solar panel . . . . .	16
3.1	Illustration of the mechanism footprint . . . . .	18
3.2	Mirrored, three-layer crank-slider MLEM . . . . .	19
3.3	Four-layer linear spring . . . . .	19
3.4	Single-layer linear spring . . . . .	20
3.5	Parallel-guiding mechanisms . . . . .	20
3.6	Two-layer parallel-guiding MLEM . . . . .	21
3.7	Single-layer parallel-guiding mechanism . . . . .	21
3.8	Four-layer linear motion MLEM spring . . . . .	22
3.9	Single-layer linear motion spring . . . . .	22
3.10	Three-layer contact-aided MLEM . . . . .	23
3.11	Two-layer parallel-guiding MLEM . . . . .	23
3.12	Actuated single-layer parallel-guiding mechanism . . . . .	24
3.13	Three-layer crank slider MLEM . . . . .	25
3.14	Metamorphic MLEM . . . . .	26
3.15	Metamorphic, bistable MLEM . . . . .	27
3.16	MLEM crank-slider with axes defined . . . . .	29
3.17	Nuremberg scissor MLEM . . . . .	30
3.18	Crank-slider and parallel-guiding MLEM . . . . .	30
3.19	Crank-slider and platform MLEM . . . . .	31
3.20	Repeated nuremberg scissor MLEM . . . . .	31
4.1	MLEM crank-slider with axes defined . . . . .	34
4.2	Cross-sectional area required for mechanism insertion . . . . .	34
4.3	Single-layer LEM spring with an out-of-plane actuation force . . . . .	35
4.4	MLEM crank-sliders and spring with an in-plane actuation moment . . . . .	35
4.5	Single-layer parallel-guiding LEM with an out-of-plane actuation moment . . . . .	36
4.6	Parallel-guiding MLEM with an in-plane actuation force . . . . .	36
4.7	Spherical single-layer LEM with an in-plane actuation moment . . . . .	37

4.8	Multi-layer LEM crank-slider with an in-plane actuation force . . . . .	37
5.1	SMA wires used to achieve in-plane force . . . . .	40
5.2	SMA wire used to achieve in-plane moment . . . . .	41
5.3	SMA sheets used to achieve out-of-plane force . . . . .	41
5.4	SMA sheet used to achieve out-of-plane moment . . . . .	42
5.5	Piezoelectric used to achieve in-plane moment . . . . .	43
5.6	Dielectric elastomer . . . . .	44
5.7	Dielectric elastomer used to achieve in-plane force . . . . .	45
A.1	Mirrored, three-layer crank-slider MLEM . . . . .	57
A.2	Four-layer linear spring, increased deflection . . . . .	57
A.3	Four-layer linear spring, increased resistance . . . . .	58
A.4	Three-layer contact-aided MLEM . . . . .	58
A.5	Two-layer parallel-guiding MLEM . . . . .	58
A.6	Three-layer crank slider MLEM . . . . .	59
A.7	Metamorphic MLEM . . . . .	59
A.8	Metamorphic, bistable MLEM . . . . .	59
A.9	MLEM Nuremberg scissor mechanism . . . . .	59
A.10	Crank-slider and parallel-guiding MLEM . . . . .	60
A.11	MLEM crank-slider and platform . . . . .	60
A.12	Nuremberg scissor MLEM repeated . . . . .	60
A.13	Spherical single-layer LEM . . . . .	61
A.14	MLEM, parallel-guiding and crank-slider mechanism . . . . .	61
A.15	MLEM composed of multiple crank-sliders, a spring, and a platform . . . . .	62

## **CHAPTER 1. INTRODUCTION**

This thesis introduces multiple-layer lamina emergent mechanisms (MLEMs). A discussion is presented on how layers are used in existing multi-layer systems and how MLEMs can potentially achieve similar functions. This is followed by a discussion on how the multi-layered nature of these mechanisms, and the interactions between the layers, are what enhance the capabilities of MLEMs and allow them to better meet design objectives. Some of these enhanced capabilities will be illustrated by three different mechanism designs used to achieve layer separation. This thesis then classifies forces and moments applied to single-layer lamina emergent mechanisms (LEMs) and MLEMs according to the geometric nature of LEMs/MLEMs and shows how MLEMs can achieve emergent motion in more simplified ways. An analysis is performed to identify suitable approaches for LEM/MLEM actuation, which focuses on actuation approaches for LEMs/MLEMs in the macro-scale. Finally, a number of novel MLEMs are presented throughout this thesis.

### **1.1 Introduction**

Lamina emergent mechanisms (LEMs) are mechanisms made from sheet materials (lamina) with motion that emerges out of the fabrication plane [1]. The top right corner of Figure 1.1 shows the planar topology of a single-layer LEM spring [2–4] and the main part of Figure 1.1 shows the LEM spring in an emergent or deflected position. LEMs are a subset of compliant mechanisms (CMs) and as such, have a number of advantages when compared to rigid-body mechanisms, including reduced wear/friction, reduced maintenance, increased precision, increased reliability, scalable, and fewer assembly steps [5, 6]. In addition to the advantages that come from being compliant mechanisms, LEMs also have an initially flat state, achieve complex motion with a simple topology, and can be fabricated using simplified and less expensive manufacturing processes.

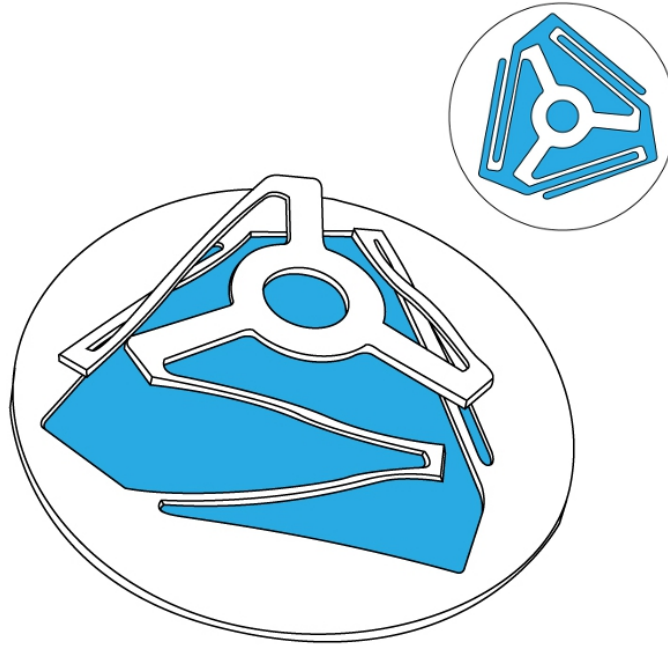

Figure 1.1: Top right: top view of single-layer LEM spring. Bottom left: single-layer LEM spring in emergent position.

Multi-layer lamina emergent mechanisms (MLEMs) are mechanisms composed of multiple layers of sheet material that achieve out-of-plane motion. A single-layer LEM could become a MLEM by adding new layers to it. MLEMs have all the same advantages of single-layer LEMs. The additional layers of MLEMs and the interactions between these layers allow MLEMs to achieve enhanced capabilities. With each additional layer, the mechanism and its motion can potentially become more complex. With enhanced capabilities and increased complexity, MLEMs can be used in a broader range of applications where it is advantageous to use multi-layer mechanisms. Many of the applications identified by Albrechtsen et al. could greatly benefit from the use of MLEMs, such as disposable mechanisms (eg. emerging packaging), novel arrays (eg. keyboard, solar array), scaled mechanisms (eg. microscopic medical devices), mechanisms with surprising motion (eg. pop-up advertising), shock absorbing mechanisms (eg. athletic flooring, turf, and footwear), and deployable mechanisms (eg. deployable shelters) [7]. Many of these applications could also greatly benefit from actuation that is suitable for use with LEMs.

One of the challenges associated with LEMs/MLEMs is finding suitable ways to actuate them. Suitable actuators will be consistent with the advantages of LEMs/MLEMs and can be incorporated into the design of a LEM/MLEM. Bulky actuators such as motors, pneumatics and

hydraulics are a few examples of actuators whose characteristics are not consistent with the advantages of LEMs/MLEMs. Thus, other actuation methods must be explored to find more suitable ways to actuate these mechanisms. Once actuation approaches for LEMs/MLEMs have been identified, designers will be able to more effectively create LEMs/MLEMs to meet the increasing need for more compact, high-performance products.

## **1.2 Background**

Multi-layer LEMs build on the previous work done in a number of technology areas within compliant mechanism research. The most obvious foundation upon which MLEMs build is single-layer LEMs. Other categories of compliant mechanisms research to which MLEM research adds are metamorphic CMs, pop-up paper mechanisms, contact-aided CMs, multi-material CMs, in-plane CMs, and microelectromechanical systems (MEMS). Each of these areas is described briefly below.

### **1.2.1 Single-layer LEMs**

LEMes are mechanisms made from sheet materials (lamina) with motion that emerges out of the fabrication plane [1]. LEMes offer the advantages of planar fabrication, a flat initial state, and monolithic composition [1]. These advantages have been demonstrated in ortho-planar mechanisms such as linear-motion springs [2], slider-cranks, four-bars, and MEMS [8]. Jacobsen et al. offered different ways to modify the flexibility of layered materials [1]. Jacobsen also presented the Lamina Emergent Torsional Joint, which allows LEMes to achieve larger deflections without changing the thickness of the base material [9]. Many of the mechanisms presented in this thesis are designed with LET joints to achieve large deflections. Figure 1.2 shows a simple single-layer LEM crank-slider mechanism composed of three LET joints. The planar topology of a LET joint [9] is shown in the top right of Figure 1.2. Winder et al. performed a study of joints suitable for LEMes [10], thus further facilitating the design of LEMes. Ferrell developed joints with specific application to metal LEMes [11]. The development and exploration of LEM joints was necessary in allowing for lamina emergent motion. Once the fundamentals of LEM motion were developed, Albrechtsen et al. identified some applications that could benefit from the characteris-



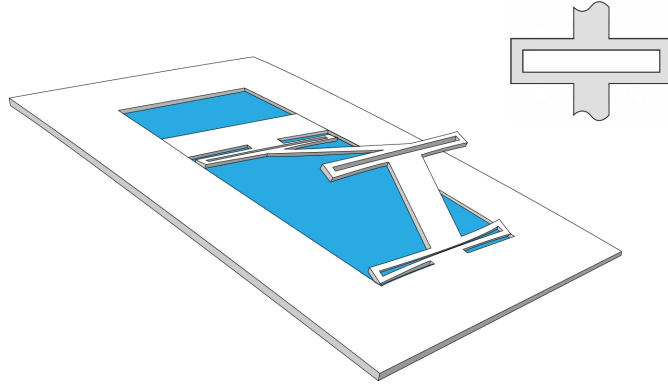

Figure 1.2: Bottom left: A single-layer LEM crank slider in emergent position. Top right: planar topology of a LET joint.

tics of LEMs [7]. A single-layer LEM could become an MLEM if additional layers are added to it.

### 1.2.2 Metamorphic Mechanisms

A metamorphic mechanism is a “self-reconfigurable mechanism,” meaning that it is a mechanism that can “change configuration from one kind to another with a resultant change in the number of effective links and mobility of movement” [12]. Initially flat sheets of cardboard can undergo metamorphic changes to produce cartons and boxes [13, 14]. Figure 1.3 shows a metamorphic LEM [15], which becomes a bistable switch when it is morphed. The top picture depicts the mechanism in its initial, flat state. The bottom, left picture shows the morphed mechanism in one stable position and the bottom, right picture shows it in the second stable position. Multi-layer LEMs can also be metamorphic mechanisms if they are designed for that purpose. With MLEMs even more complex metamorphic mechanisms are possible than with single-layer LEMs because of the possible integration of multiple layers.

### 1.2.3 Pop-up Paper Mechanisms

Jackson [16] states that a pop-up is “a self-erecting, three-dimensional structure, formed by the action of opening a crease.” Pop-up paper mechanisms can be described using a kinematic or compliant mechanism representation [17]. Each fold in a paper mechanism can be modeled as

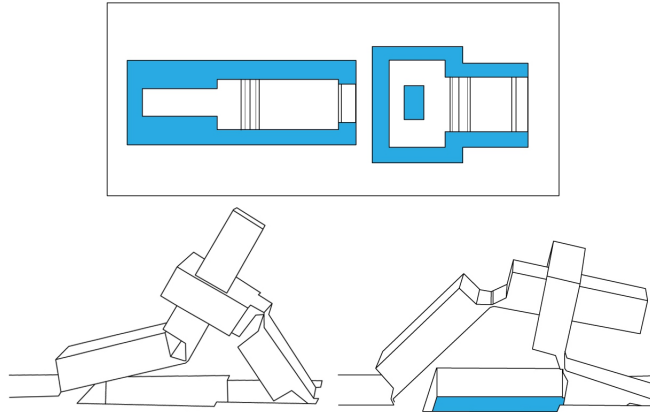

Figure 1.3: At the top is a metamorphic LEM in its flat, initial state. The bottom, left image shows the metamorphic LEM, morphed and in one stable position. At the bottom, right the mechanism is morphed and in the other stable position.

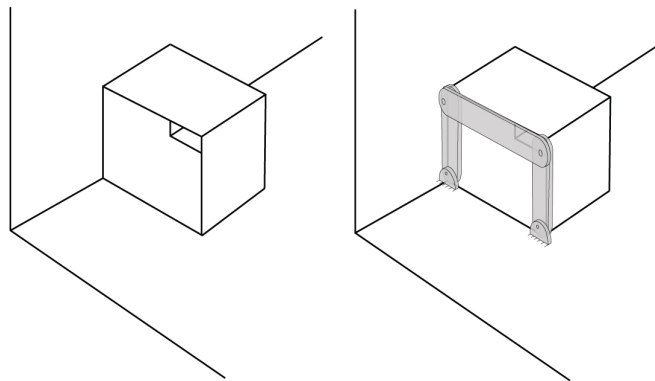

Figure 1.4: On the left, a planar double-slit paper mechanism. On the right, a four-bar imposed on the double-slit mechanism to show a kinematic representation of the paper mechanism.

a joint. Figure 1.4 shows one example of a paper mechanism, a planar double-slit mechanism, and its kinematic representation, a 4-bar mechanism [17]. Pop-up paper mechanisms are often made of layers and are flat in their initial state. Multi-layer LEMs are also made of layers, have a flat initial state, and their motion can be modeled using kinematic representations. These parallels show that motions similar to those attainable in paper mechanisms can potentially be achieved in MLEMs.

#### 1.2.4 Contact-aided Compliant Mechanisms

Compliant mechanisms typically exhibit smooth-path motion. “Intermittent contact interactions allow [contact-aided compliant mechanisms] to exhibit non-smooth motion or force trans-

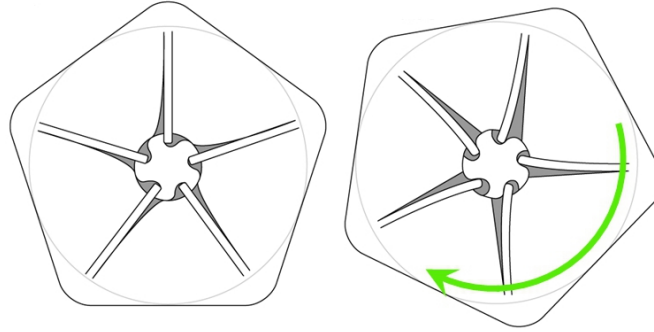

Figure 1.5: A compliant contact-aided revolute joint. To the left the mechanism is shown in its initial, undeflected position. To the right the mechanism is shown in its deflected position.

mission characteristics similar to those exhibited by rigid-body mechanisms while retaining the advantages of scalability and ease of manufacture that are associated with CMs” [18]. Contact interactions allow for motion that is not attainable in CMs without them [19]. This allows for the design of novel CMs such as a mechanism that converts “reciprocating translation into enclosing curved paths” [20,21] and a “compliant contact-aided revolute joint” [22] shown in Figure 1.5. Adjacent layers of a MLEM in its flat, initial state are in contact with each other. Multi-layer LEMs can be designed to be contact-aided CMs. As such a mechanism moves, there may be existing contact points between layers (from the initially flat state of the mechanism) or new contact points (as the mechanism moves out of its initial state) that exhibit contact-aided behavior.

### 1.2.5 Multi-material Compliant Mechanisms

It can be advantageous to design compliant mechanisms to be made from multiple materials. Researchers have studied many ways to design multi-material compliant mechanisms. Some of these design techniques include: level-set methods [23, 24], topology optimization methods [25, 26], and the use of three-dimensional wide curves [27]. Others have researched different techniques for manufacturing multi-material CMs. One method used in manufacturing multi-material CMs is multi-material molding [28]. Figure 1.6 shows two clips, the one on the left has a rigid-body hinge and is composed of two rigid halves and a metal spring. The clip on the right of Figure 1.6 is a multi-material clip. The two halves of the multi-material clip are made from a rigid material while the center, circular part of the clip is made from a compliant material that

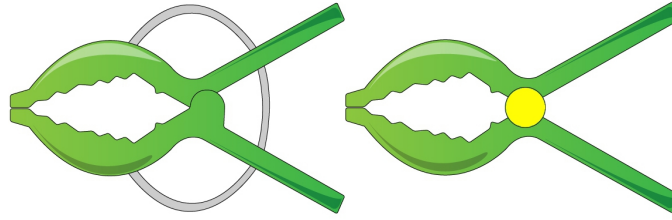

Figure 1.6: The clip on the left is made from hard plastic (green), with a rigid-body hinge and a metal spring. The clip on the right is made mostly from the same hard plastic as the clip on the left, but the rigid-body hinge is replaced with a flexible material (yellow) that acts as both a hinge and spring.

functions as both a spring (by storing energy through elastic deformation) and as a hinge. Each layer of a multi-layer LEM can be a different material. Thus, MLEMs can easily be designed as multi-material compliant mechanisms.

### 1.2.6 In-plane Compliant Mechanisms

In-plane compliant mechanisms also have some parallels with LEMs. Both can be fabricated from sheet materials and both have an initially flat state. The main difference between in-plane compliant mechanisms and LEMs is the motion. LEMs can achieve motion in three dimensions while in-plane compliant mechanism motion is two-dimensional (motion remains within the plane of fabrication). While numerous in-plane compliant mechanisms have been created, here are just a few examples: contact-aided compliant mechanisms [18, 19, 22], linear motion mechanisms [29–32], and micromechanisms [33–35]. All of the mechanisms presented in these citations have motion that remains in the plane of fabrication. Thus, actuation in these examples typically occurs as in-plane forces or moments are applied to the mechanism. In-plane forces and moments can also be used to achieve motion in LEMs and MLEMs, and will be discussed in more detail later.

### 1.2.7 Microelectromechanical Systems

There are many parallels between microelectromechanical systems (MEMS) and LEMs. Both are created from layers, both have a flat initial state, and both can achieve out-of-plane motion. Many MEMS can be classified as LEMs if they are designed with compliant members and have

emergent motion. With such strong parallels between them, MEMS could provide inspiration and insight into the actuation of macroscopic LEMs.

MEMS are created layer by layer through deposition and micromachining processes such as bulk micromachining [36] and surface micromachining [37]. There are a variety of MEMS actuators that have been developed. Some of the more common MEMS actuation techniques are electrostatic actuation [38], thermal actuation [39], magnetic actuation [40], and piezoelectric actuation [41, 42]. Some of these MEMS actuation techniques are scalable and thus could be used with macroscopic LEMs. While other MEMS actuation techniques are not currently achievable in the macro-scale, they could still provide insight into innovative actuation approaches to be used in macroscopic LEMs. The MEMS actuation techniques that are not scalable up to the macro-scale will not be emphasized in this thesis. It is assumed that micro LEMs will use the same actuation techniques as those already used in MEMS.

Single-layer LEMs, metamorphic CMs, pop-up paper mechanism, contact-aided CMs, multi-material CMs, in-plane CMs, and MEMS are all a part of the foundation upon which MLEM technology is built. In addition to the work done in the technology areas discussed above, MLEM design can also benefit greatly from the study of other layered systems. On a daily basis people interact with systems of layers. Much of what is known about these layered systems can be applied to MLEMs and will be discussed more in Chapter 2.

## **CHAPTER 2. MULTI-LAYER SYSTEMS INSPIRE MLEMS**

Multi-layer systems are readily found in nature and in many man-made products. Each layer can serve a different purpose. Layers are often used for structural, functional and aesthetic purposes. Together the layers create a system, such as a snowboard (see Figure 2.1). Since MLEMs are also layered systems, then studying the purposes of layers and layered systems in general helps increase the understanding of how multi-layer LEMs can be more effectively designed to achieve certain objectives.

There are a variety of applications where layers are used to deal with different types of energy. Layers can transfer and transform energy. Some ways that layers do this is through heat energy transfer, chemical energy transfer, mechanical energy transfer, electrical energy transfer, light energy transfer, and different types of energy transformation. Each of the following subsections will discuss a type of energy application found in layers and how it can potentially be applied to the design of MLEMs.

### **2.1 Mechanical Energy Transfer**

Mechanical energy transfer between layers is probably the most prevalent form of energy transfer between layers. There are many examples of how layers transfer mechanical energy. Shoe soles are made up of layers (see Figure 2.2). The material and geometry of the layers vary according to the type of shoe (such as walking, running, rock climbing, cycling). Each type of shoe transfers mechanical energy according to the different loading conditions for which the shoe is designed. For example, layers of a cycling shoe are designed for stiffness to transfer as much energy as possible from the rider to the pedal. On the other hand, the goal of walking shoes is comfort and often the layers of the shoe achieve this by absorbing some of the impact and distributing the load evenly across the foot.

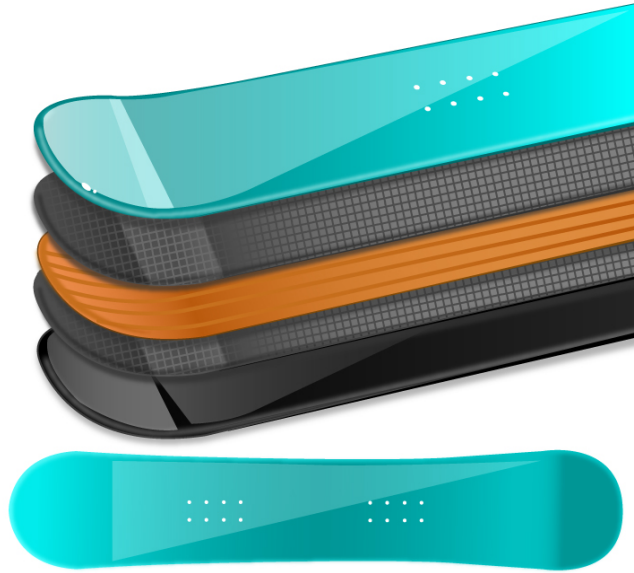

Figure 2.1: The image at the top shows the different layers of a snowboard. The bottom is a top view of a snowboard.

Listed below are some other examples of how multi-layer systems transfer mechanical energy:

- The layers of snowboards and skis transfer energy between the rider and the surface of the snow. The layers can be designed to create either a stiffer or more flexible riding surface, depending on the riding style for which it is designed.
- The layers of bullet proof vests absorb some energy and transfer the rest of the energy from essentially a point load of a bullet into a distributed load across the chest/abdominal region of the body.
- Similar to a bullet proof vest, the layers of football pads transfer energy from a concentrated load of a player tackling the ball carrier into a distributed load across the area of the body where the pad is placed.
- Layers of leaf springs are used to store and transfer energy between the axle and the frame of the vehicle/trailer.
- Layers of car tires provide both flexibility (rubber) and needed strength (plies and steel belts).



Figure 2.2: A shoe, with an exploded view of the layers of the shoe sole

- Layers of composite materials are often oriented in different directions to obtain certain characteristics, such as directional strength, which will affect how energy is transferred.

Similar to the above examples, multi-layer LEMs could also be designed to transfer mechanical energy. One such way is that MLEMs could be designed such that they could be incorporated into impact absorption applications.

## 2.2 Thermal Energy Transfer

Multiple layers can control the rate of heat transfer. Some applications use layers to transfer heat to a specified area, such as with clothing irons and frying pans (see Figure 2.3). And other applications use layers to remove heat from a specific area, such as with heat sinks. Some applications use layers to keep the heat contained in a certain area, such as with multiple layers of clothing during the winter. And other applications use layers to keep heat out of a certain area, such as with insulation in buildings during the summer. A common example where multiple layers are used to vary the rate of heat transfer is skin. Typically in cold weather, the layers of skin work together to restrict blood flow near the surface of the skin, which in turn decreases the rate of body heat lost





Figure 2.3: A frying pan, with a section cut away and a zoomed-in view of the base layers of the frying pan

through the skin. Typically in hot weather, the layers of skin work together to increase blood flow near the surface of the skin and induce sweating, which in turn increases the rate of body heat lost through the skin.

Multi-layer LEMs, too, could be designed to control the rate of heat transfer. One way to do this is to design a MLEM for insulation. A MLEM could be actuated to separate the layers, thus creating a space between the layers that could be filled by some insulating medium, such as air. In this open position the mechanism would act as a good insulator. In its closed position the mechanism would transfer heat at a faster rate than it would in the open position.

### 2.3 Electrical Energy Transfer

There are some applications where layers are used to transfer electrical energy. Membrane switches, as shown in Figure 2.4, are made of multiple-layers in order to transmit electrical energy when a button is pressed. Circuit boards are made from layers and designed to transfer electricity between the layers and elements of the circuit board. Keyboards are also made up of layers and are used to transfer electrical signals.

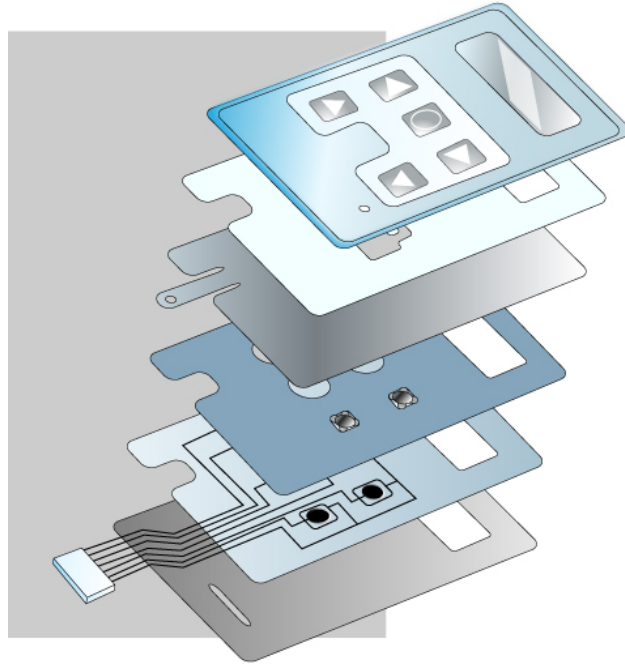

Figure 2.4: The layers of a membrane switch

Multi-layer LEMs could also be designed to transfer electricity between layers. In a MLEM electronic switch, the actuation of the layers could open and close circuits.

## 2.4 Chemical Energy Transfer

Chemical energy transfer across multiple layers is most commonly found in nature. In nature multiple layers of tissue are often used to regulate the transfer of chemical energy. A simple example is the intestine (see Figure 2.5); useful chemical energy from food is transferred across the layers of the intestine wall into the blood stream while waste is kept out of the blood stream.

Multi-layer LEMs could also be designed to regulate the transfer of chemical energy. One way this could be achieved is by creating a multi-layer mechanism membrane of variable permeability. In its closed position the membrane would be less permeable and in its actuated position it would be more permeable.

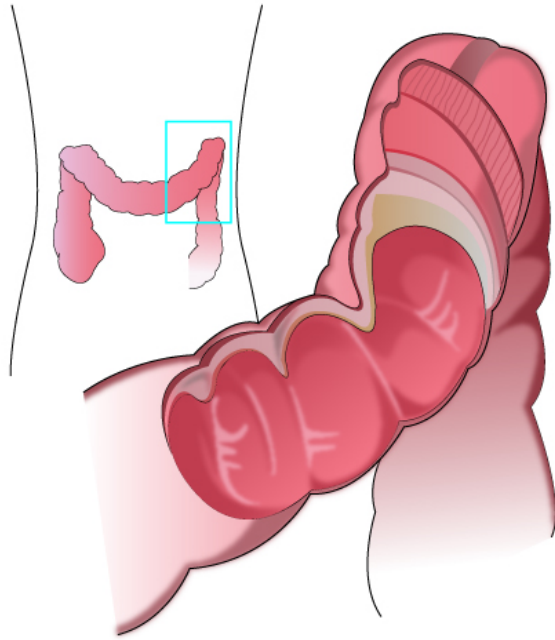

Figure 2.5: The intestine, with the different layers shown

## 2.5 Light Energy Transfer

Layers can be used to regulate the transfer of light energy. A tinting layer is sometimes applied to car windows to reduce the amount of light energy that is allowed to pass through. The screens of TVs, cell phones (see Figure 2.6) and computers are designed to transfer light through the layers and transmit that light to the user.

Multi-layer LEMs could also be used to regulate the amount of light energy transfer through layers. In the closed position, the MLEM could block light from passing through the mechanism, and in the actuated position it could allow some light to pass through the mechanism.

## 2.6 Energy Transformation

Energy transformation is commonly found in nature and in everyday products. Layers can be an efficient way to transform energy from one type to another. Layers are often used in energy transformation applications because they are easy to manufacture. Some examples of how layers transform energy are:

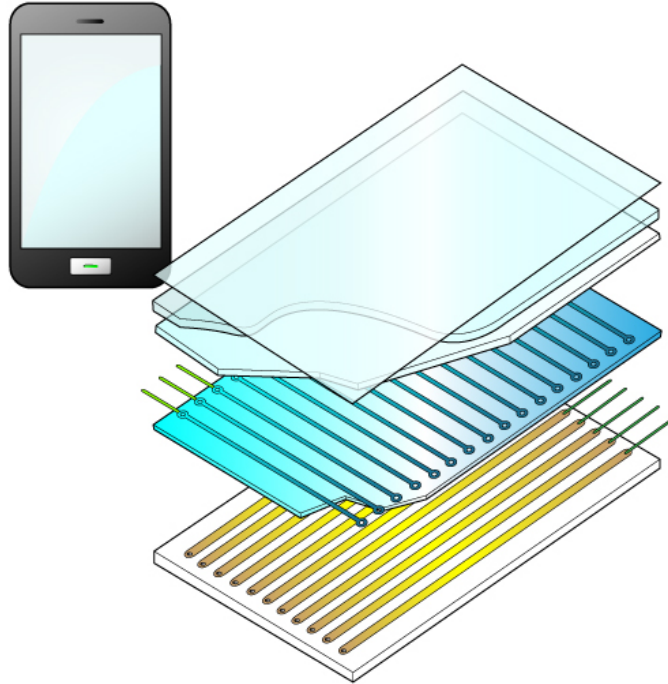

Figure 2.6: Cell phone, with the different layers of the screen shown

- TVs, cell phones and computer screens transform electrical energy to light energy.
- Large solar panels, often found on buildings (see Figure 2.7), and small solar panels, often found on calculators, transform light energy to electrical energy.
- Speakers transform electrical energy to sound energy.
- Microphones transform sound energy to electrical energy.
- A magnet moving through a solenoid and piezoelectric materials can both transform mechanical energy to electrical energy.
- Piezoelectric materials and motors transform electric energy to mechanical energy.
- Photosynthesis in plants transforms light energy to chemical energy.
- Batteries transform chemical energy to electrical energy.

Multi-layer LEMs could also be designed to transform energy from one type to another. MLEMs could have piezoelectric material incorporated into them so that mechanical energy could be transformed to electrical energy.

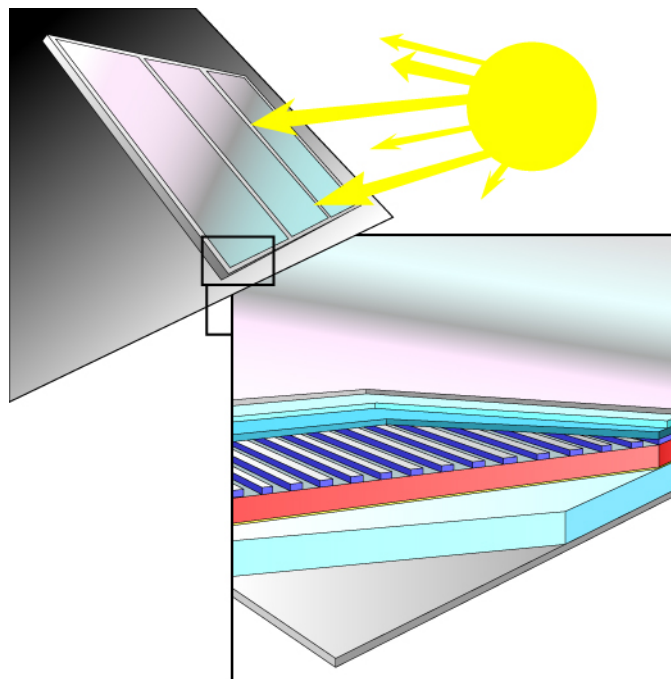

Figure 2.7: A solar panel on a roof with radiation from the sun shown as arrows. The close up view shows the layers of a solar panel.

### **CHAPTER 3. ADDITIONAL LAYERS ENHANCE THE CAPABILITIES OF MLEMS**

The enhanced capabilities, made possible with additional layers and layer interactions, are discussed individually in this section.

For the purposes of this chapter, the “mechanism footprint” is defined as the total area of the fabrication plane required to produce a MLEM. Once a mechanism is created on the fabrication plane, the outer boundary of that mechanism constitutes the footprint. Within an individual layer it is hard to create additional mechanisms in the same footprint as another mechanism. Since MLEMs are made from multiple layers, then even if the footprint of one layer is used to make a mechanism, that same footprint on another layer can still be used to create a mechanism. Figure 3.1 shows the concept of the mechanism footprint. The left image of Figure 3.1 represents an exploded view of the mechanism layers and shows that the same area can be used in each layer to create a mechanism. The image at the right of Figure 3.1 shows the layers stacked, representing a MLEM in its assembled, initially flat state. When layers are stacked, the individual mechanisms from each layer can interact to make a more complex mechanism and allow for design objectives to be more easily achieved.

For the purposes of this chapter, a “layer interaction” is defined as any change in the behavior of a layer due to the presence of an additional layer. These layer interactions can include changes in force-deflection characteristics, changes in motion path, or any other altered behavior that is different than it would have been in the absence of the additional layer. This typically happens when layers are joined together, come in contact with each other and/or move together. Layer interactions make it possible for the behavior of the layers to combine, which in turn, allows for enhanced capabilities.

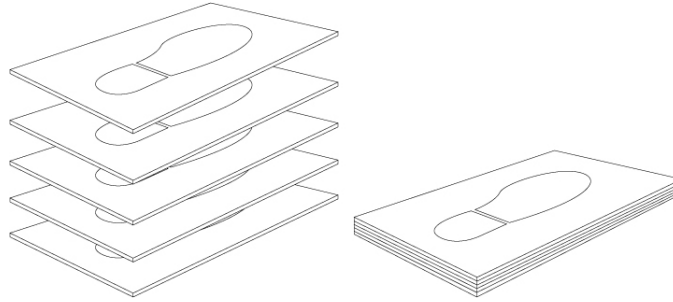

Figure 3.1: Illustration of the mechanism footprint. Exploded view to the left and assembled view to the right.

### 3.1 Increased Usable Area

Each additional layer accounts for a slight increase in thickness, a large increase in usable area for creating mechanisms and no increase in mechanism footprint. For example, Figure 3.2(a) shows the top view of a mirrored three-layer crank slider mechanism. This mechanism consists of 2 emergent layers (white) and an actuation layer (black). Figure 3.2(b) shows the mechanism in an actuated position. The mechanisms in each layer were created using comparable amounts of area. A much larger mechanism footprint would be needed for a single-layer mechanism to be able to have two emergent mechanisms and an actuation slider like those shown in Figure 3.2(b). Also, it is impossible for a single-layer mechanism to have mirrored motion, as is shown in the three-layer crank slider MLEM. For mechanisms to emerge from the top and bottom such that the motion is mirrored, more than one layer is needed.

### 3.2 Increased Deflection

At a given stress, each layer can achieve a certain amount of deflection. The amount of deflection a layer can achieve depends on the design, including number of joints, the joint types and the size of the footprint. At a given stress and mechanism footprint, each additional layer added to a MLEM can allow for more deflection. Figure 3.3 shows a four-layer MLEM spring in a deflected position. Figure 3.4 shows a single layer of this mechanism, also deflected. Note that each layer of this spring has the same topology as the device in Figure 1.1. At the same level of stress, four times the deflection is possible with the four-layer MLEM spring as compared to a single-layer of this mechanism.

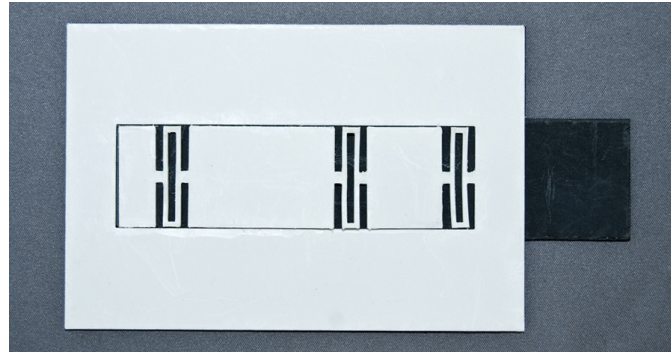

(a) Top view

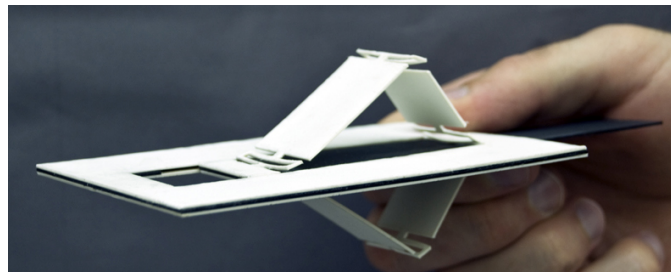

(b) In actuated position

Figure 3.2: Mirrored, three-layer crank-slider MLEM

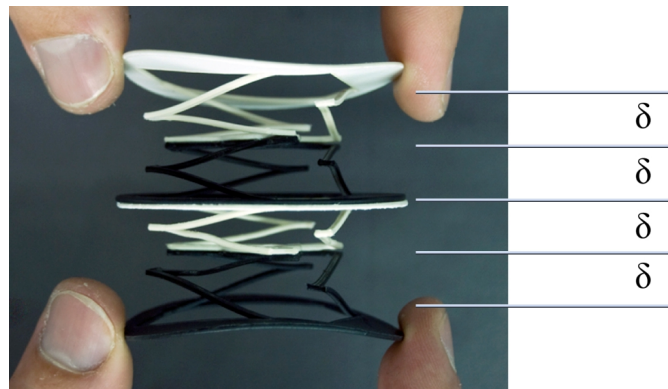

Figure 3.3: Four-layer linear spring in deflected position

### 3.3 Reduced Footprint

Multiple layers provide a way to achieve the same motion in a reduced mechanism footprint. As can be seen in Figure 3.5, the parallel-guiding MLEM has a reduced mechanism footprint as compared to the parallel-guiding single-layer mechanism. Both mechanisms use the the same size LET joints, but the additional layer of the MLEM allows the joints and links of one layer to



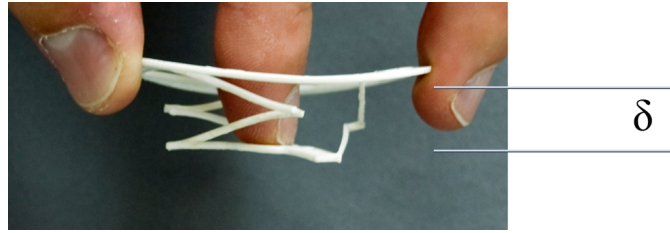

Figure 3.4: Single-layer linear spring in deflected position

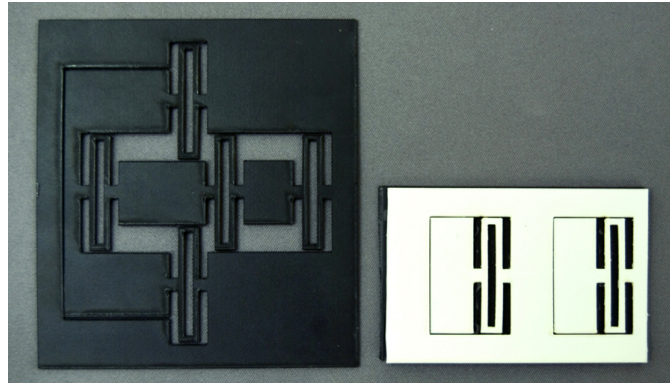

Figure 3.5: On the left is a single-layer parallel-guiding mechanism. On the right is a two-layer parallel-guiding MLEM

be located in the same mechanism footprint as joints and links of the other layer, thus allowing for a smaller mechanism footprint. In Figures 3.6 and 3.7 it can be seen that both mechanisms have the same motion: both are parallel-guiding mechanisms.

### 3.4 Resistance and Energy Storage

The presence of additional layers in MLEMs allows for layers to act together with different force, deflection and stress characteristics than can be achieved in a single-layer. For example, one solid piece of spring steel as thick as a leaf spring would behave much differently than a leaf spring and would have a much higher stress in bending to achieve the same deflection. The layers of spring steel that compose a leaf spring provide its functional characteristics. Likewise, each additional layer of a MLEM will alter the mechanism's functional characteristics. For example, with each layer added to a MLEM spring, the force required to deflect the spring will increase. Figure 3.8 shows a four-layer MLEM spring in a deflected position. Figure 3.9 shows a single-layer of the

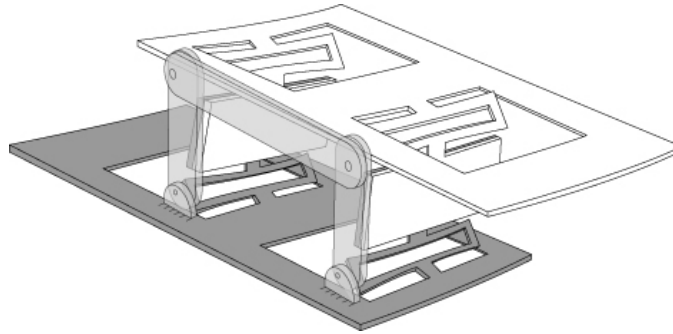

Figure 3.6: Two-layer parallel-guiding MLEM in an actuated position

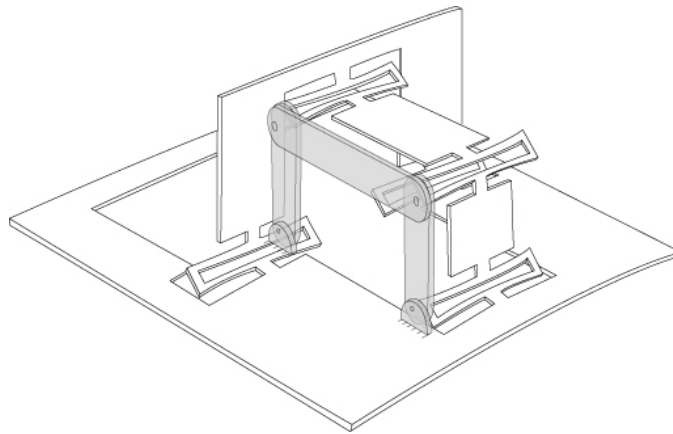

Figure 3.7: Single-layer parallel-guiding mechanism in an open actuated position

MLEM spring, also in a deflected position. Each layer of this spring has the same topology. At the same amount of deflection, both the MLEM spring and a single layer of the spring have the same amount of stress. But, at the same amount of deflection, the four-layer MLEM spring requires four times the force and can store four times the energy.

### 3.5 Contact-aided Interactions Between Layers

Contact-aided motions occur when one layer comes in contact with itself or another layer. Adjacent MLEM layers are in contact with each other in their initially flat state. As soon as the MLEM is actuated there is potential for contact-aided motion to occur. Additionally, through the motion of the mechanism, layers could continue to come in contact with one another and have more contact-aided interactions. The three-layer button shown in Figure 3.10 has two contact interactions during its motion when a vertical downward force is applied to the top of the button:

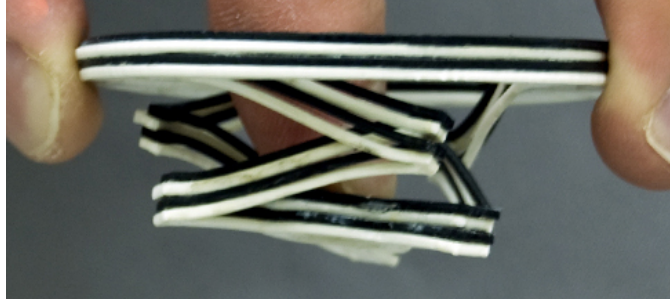

Figure 3.8: Four-layer linear motion MLEM spring in deflected position

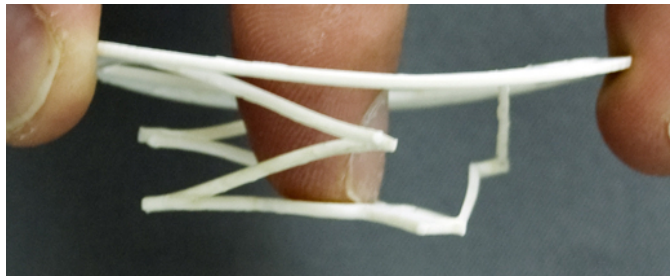

Figure 3.9: Single-layer linear motion spring in deflected position

1) when the top (white) layer comes in contact with the middle (black) layer and the second when the middle (black) layer comes in contact with the bottom (white) layer. The force/deflection curves have discontinuities at each of these contact interactions.

### 3.6 Biased Motion

In a single-layer mechanisms all of the links and joints lie in the same plane, thus they are change-point mechanisms. Having multiple stacked layers may help to bias the motion in the desired direction. Figure 3.11 shows a two-layer parallel-guiding mechanism. When this mechanism is in its flat, initial state the mechanism can only move into the open configuration. This is due to the fact that each layer of the mechanism inhibits the other layer from going into a crossed configuration. The single-layer parallel-guiding mechanism shown in Figure 3.12, on the other hand, could go into either the open or crossed configuration when actuated.

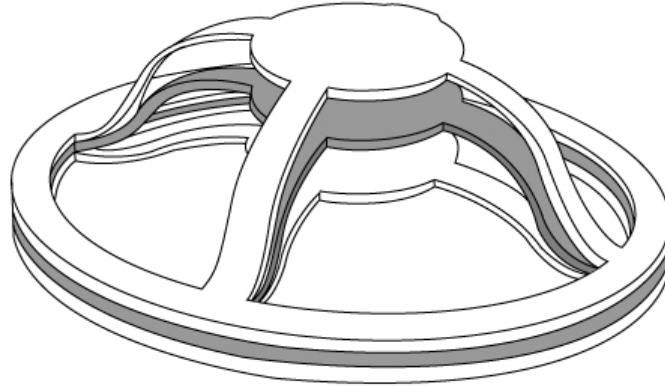

Figure 3.10: Three-layer contact-aided MLEM

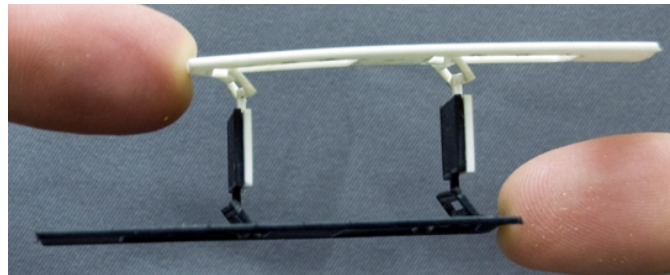
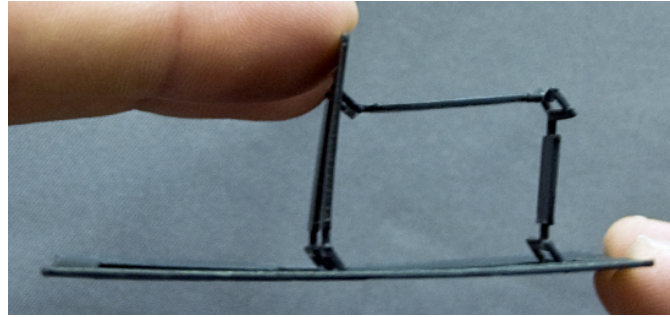

Figure 3.11: Actuated two-layer parallel-guiding MLEM (only actuates into open position)

### 3.7 Increased Actuation Options

The added layers of MLEMs allow for more actuation options. In a single layer mechanism actuation and emergent motion must occur with the same layer. With multiple layers available, some layers of a MLEM could be used as actuation layers while others are used as emergent layers. Having layers dedicated to specific tasks can facilitate the design of the mechanisms. Figure 3.13 shows a three-layer crank-slider MLEM consisting of a white base layer, a black actuation layer and a white emergent layer. Figure 3.13(a) shows the three separate layers of the mechanism prior to mechanism assembly. Figure 3.13(b) shows the assembled mechanism in an initial, flat position. The mechanism is actuated as the mechanism slider is pulled. The mechanism slider is part of the black layer of the mechanism. Note that the black tab in Figure 3.13(b) (which protrudes out the mechanism's side nearest the hand in the picture) is the slider that moves. The slider protrudes out even more in Figure 3.13(c) when the mechanism is actuated by pulling on the mechanism slider.



(a) Open configuration

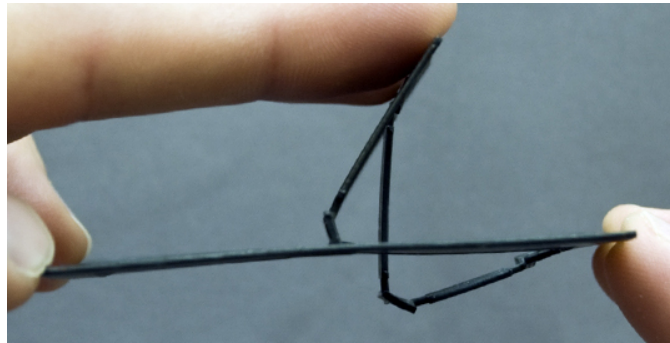

(b) Crossed configuration

Figure 3.12: Actuated single-layer parallel-guiding mechanism

### 3.8 Enhanced Metamorphic Interactions

In a metamorphic MLEM, there is more working area from which a mechanism may be created. A single-layer mechanism can be metamorphic, but a multi-layer mechanism can morph in ways that are much simpler to achieve. With metamorphic MLEMs one layer can morph and attach to another layer. Metamorphic interactions are much easier to create in MLEMs because multiple mechanisms can exist in the same footprint. With metamorphic single-layer mechanisms, it can be more difficult for a mechanism to morph because there is a greater distance for the metamorphic part of the mechanism to travel. This is because at least one part of the metamorphic mechanism must travel outside of its own footprint so that it can interact with another part of the mechanism.

Multi-layer LEMs also allow layers to slide and lock into place to create metamorphic interactions. Interlocking sliders are very effective in MLEMs because adjacent layers can constrain the sliding locks to a plane. Figure 3.14 shows a metamorphic MLEM in 5 different positions: (a) in initially flat state, (b) in an emergent state, (c) in one morphed position with double-crank 4-bar

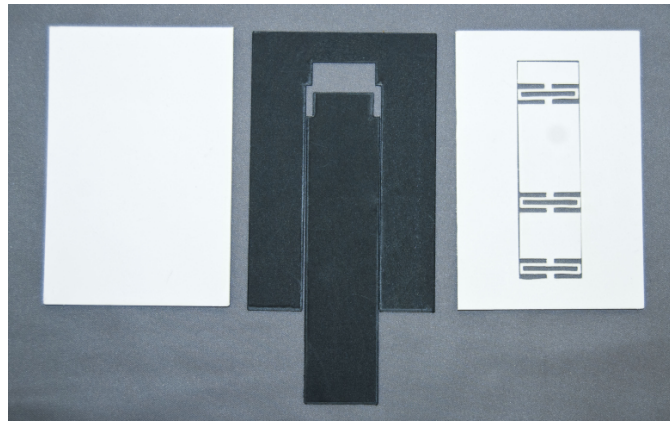

(a) The three different layers shown separately, pre-assembled



(b) Top view of mechanism in initial, flat position



(c) In actuated position

Figure 3.13: Three-layer crank slider MLEM

motion, (d) in another morphed position with parallel-guiding 4-bar motion, and (e) in third morphed position with double-rocker 4-bar motion. All of the morphed positions are made possible by interlocking sliders that lock the mechanism slider into place. Restricting the movement of the mechanism slider reduces the mechanism's motion by one degree of freedom, which results in a 4-bar mechanism motion.

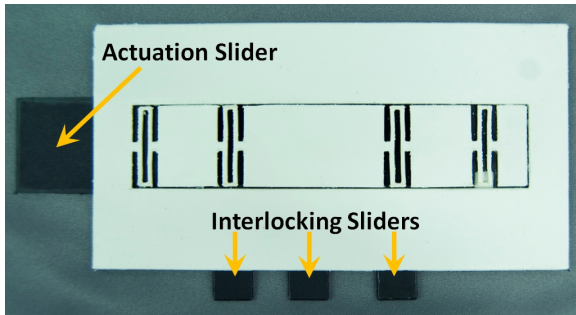

(a) Top view of MLEM in initially flat state

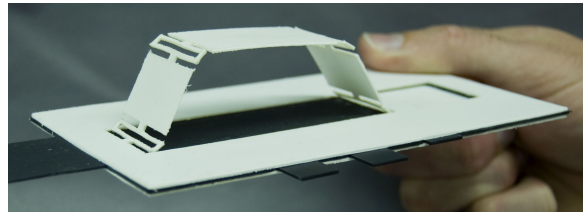

(b) MLEM in emergent position

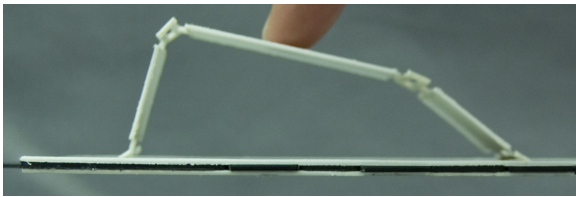

(c) MLEM in one morphed position with double-crank 4-bar motion

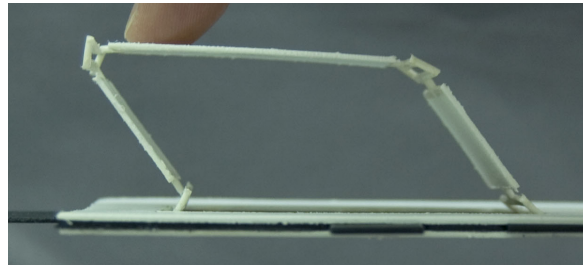

(d) MLEM in another morphed position with parallel-guiding 4-bar motion

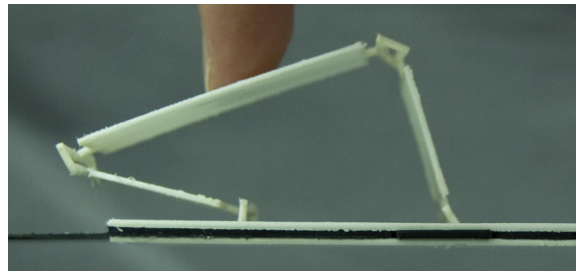

(e) MLEM in third morphed position with double-rocker 4-bar motion

Figure 3.14: Metamorphic MLEM

### 3.9 Bistability

Usually a preforming process or a metamorphic interaction is required for a MLEM to be bistable. MLEMs can easily achieve metamorphosis, such as when an interlocking slider is incorporated into the mechanism, which facilitates the creation of bistability in MLEMs. Figure 3.15 shows (a) a metamorphic, bistable MLEM in its initially flat state, (b) in one of the stable positions in its morphed condition, the interlocking slider having locked the mechanism's actuation slider in place, and (c) in the other stable positions in its morphed condition. The layers of the MLEM

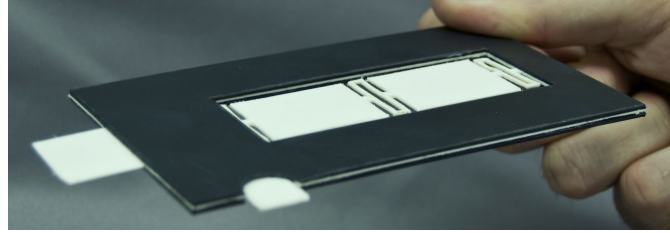

(a) Initially flat state of MLEM

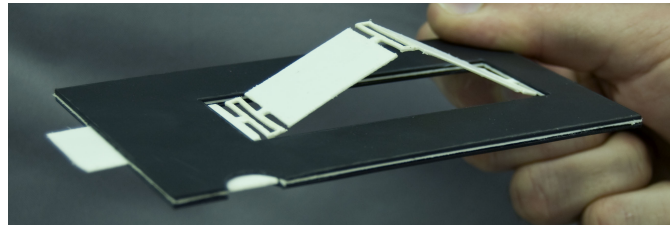

(b) One stable position of the morphed state

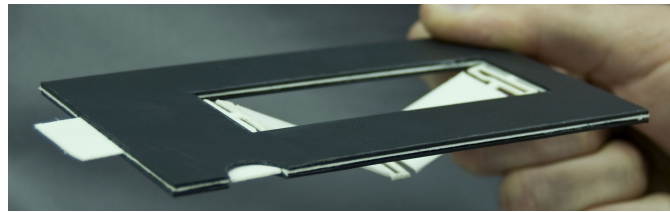

(c) Other stable position of the morphed state

Figure 3.15: Metamorphic, bistable MLEM

enhance the mechanism's capabilities by facilitating the metamorphic process, thus facilitating bistability.

### 3.10 MLEM Layer-Separating Mechanisms

Separation of layers is something that can be achieved by MLEMs. MLEMs are well-suited for applications where separating layers is one of the design objectives. Separation of layers could be useful for the following applications:

- Impact absorption: The layers of MLEMs could be separated and metamorphically lock into place. Upon impact the layers, if designed properly, could potentially absorb more energy than if the layers were laying flat.
- Energy storage: Separating MLEM layers allows for energy storage. Since MLEMs are compliant mechanisms, energy is naturally stored as the mechanisms are actuated. Upon



actuation, MLEMs store energy through elastic deformation and as they are returned to their flat, initial state they release the stored energy. The amount of energy stored could be enhanced by using additional layers as energy storage layers.

- Heat transfer control: The rate of heat transfer through a MLEM could be altered by separating layers. In its flat position, the MLEM would transfer heat at a certain rate. In its actuated position, the rate of heat transfer could be reduced because of the separation between the layers. The space between layers could be filled with air or some other insulating medium. The separation of layers could also create a vacuum if the edges were sealed.
- Electrical contacts or switches: MLEM layer separation could possibly be used to open and close electrical contacts.
- Different types of energy transformation: MLEMs could possibly use layer separation to transform energy from one type to another. The mechanical energy involved in separating layers could possibly be transformed into other energy types.

### 3.10.1 MLEM Layer-separating Conventions

Three layer-separating MLEMs are presented in the following sections, and the following conventions have been established for their comparison (see Figure 3.16 for reference):

- The “actuation slider” refers to the slider that is pulled to actuate the MLEM. The actuation slider is constrained to move only in the y-direction.
- Theta ( $\theta$ ) refers to the angle between the actuation slider and the link adjacent to the slider on the emergent layer.
- The y-axis refers to the axis along which the actuation slider is pulled to set the mechanism into motion.
- The x-axis refers to the axis which is perpendicular to the y-axis and in-plane with the layers of the mechanism in its flat position.
- The z-axis refers to the axis perpendicular to the mechanism in its flat position.

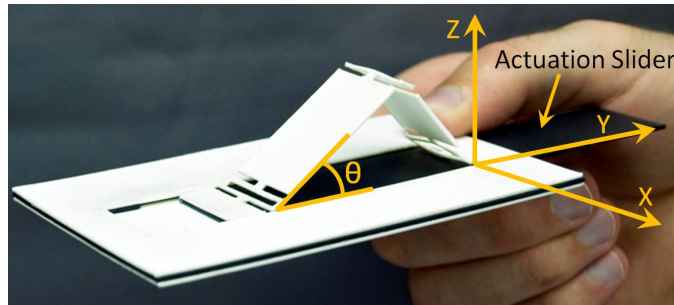

Figure 3.16: MLEM crank-slider, axes defined as show

- The mechanism footprint refers to the total area of the mechanism in the xy-plane when the mechanism is in its initial, flat state.

There are a number of different ways to configure a multi-layer LEM to achieve a desired design objective. To demonstrate this, the objective of layer separation was chosen. Separating layers can be accomplished with a number of different designs. Three designs that achieve layer separation are presented below.

### 3.10.2 MLEM Nuremberg Scissors

The Nuremberg scissor mechanism is well known for its relatively small input displacement with a large output displacement. One objective that the Nuremberg scissor mechanism can achieve in MLEMs is separating layers, as shown in Figure 3.17. It allows for a large displacement of the top layer in the positive z-direction with little relative motion of the top layer in either the x-direction or y-direction.

### 3.10.3 MLEM Crank Slider and Parallel-guiding Mechanism

The mechanism shown in Figure 3.18 is composed of a MLEM parallel-guiding mechanism (similar to the one presented in Figure 3.11) which is attached on top of a MLEM crank slider (similar to the one presented in Figure 3.7). Because the crank slider and the parallel-guiding mechanism share a common link, both are set into motion by pulling the actuation slider. Actuating this mechanism causes the layers to separate in the z-direction. And because this separation in the



Figure 3.17: MLEM Nuremberg scissor mechanism used to separate layer

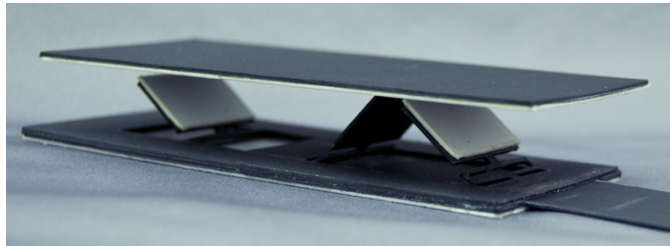

Figure 3.18: MLEM crank-slider attached to parallel-guiding mechanism to separate layers

z-direction is caused by the motion of the parallel-guiding mechanism, then the top layer also moves in the y-direction.

#### 3.10.4 MLEM Crank-slider and Platform

The mechanism shown in Figure 3.19 is composed of a crank slider and a platform. The platform's motion is constrained by a series of 4 springs, one near each corner of the mechanism. The springs allow the platform to rise in the z-direction while simultaneously restricting motion in the x-direction and y-direction. The crank-slider pushes up on the platform as it is actuated.

This example of layer separation demonstrates the following enhanced capabilities of MLEMs:

- Increased usable area, all three mechanisms have joints and links located on different layers, but within the same footprint

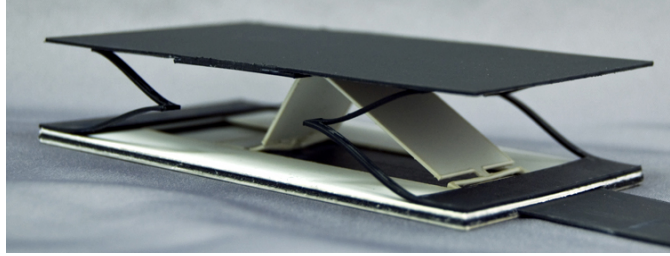

Figure 3.19: MLEM crank-slider pushes up on platform to separate layers

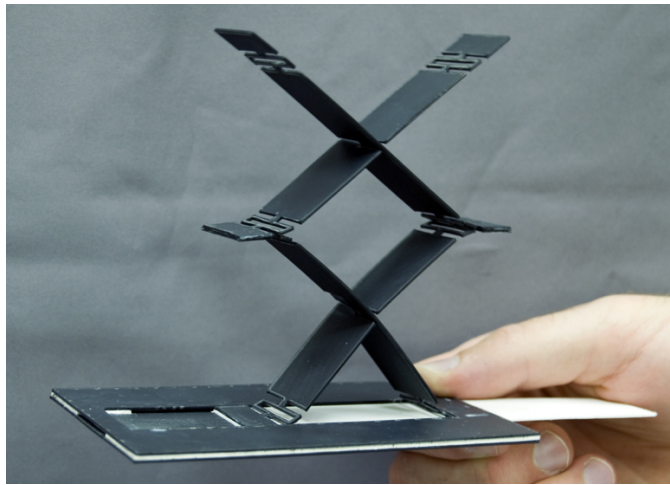

Figure 3.20: Nuremberg scissor MLEM repeated to show increased deflection in z-direction

- Increased deflection, the Nuremberg scissor MLEM can be repeated, as shown in Figure 3.20. This MLEM can achieve deflections much greater than would be attainable in a single-layer mechanism with the same size footprint
- Reduced footprint, all three mechanisms have a much smaller footprint than a single-layer mechanism with the same motion would require
- Biased motion interactions, all three mechanisms are biased to move in the positive z-direction
- Resistance and energy storage, the MLEM crank-slider and platform has additional resistance and energy stored in the mechanism due to the springs located near each corner of the mechanism

Table 3.1: Characteristics of three layer-separating MLEMs: 1) Nuremberg scissor mechanism, 2) Parallel-guiding and crank-slider mechanism, and 3) Crank-slider and platform mechanism.

Mechanism	Number of Layers	Mechanism Footprint ( $in^2$ )	Z-displacement ( $in$ ) at $\theta = 45$ deg	Y-displacement ( $in$ ) at $\theta = 45$ deg
1) Nuremberg	6	13.75	2	0
2) P.G. & C.S.	5	10.75	5/8	1/4
3) Crank-slider	5	12.5	5/8	0

Table 5.1 summarizes some of the characteristics of the three layer-separating MLEMs that are most applicable to layer separation. The table includes the characteristics of number of layers, size of footprint, z-displacement at  $\theta = 45$  deg, and y-displacement at  $\theta = 45$  deg. Although all three mechanisms achieve layer separation, which is the main objective, each mechanism has some advantages when compared to the others. For example, the Nuremberg scissor mechanism achieves the largest z-displacement, the parallel-guiding & crank-slider mechanism has the smallest footprint, and the crank-slider & platform mechanism has the fewest number of layers for a mechanism that has no relative motion in the y-direction. This table illustrates that MLEM design configurations can affect the characteristics of the MLEM.

## CHAPTER 4. LEM AND MLEM FORCE AND MOMENT CLASSIFICATION

Since LEMs and MLEMs lie flat in their initial state, a force or moment must act on this planar geometry to set the LEM/MLEM into motion. Forces and moments applied to LEMs and MLEMs are classified as acting either in-plane or out-of-plane. The geometric nature of LEMs and MLEMs is one reason for this distinction. Another reason is that sliders in LEMs and MLEMs generally move within the plane of the mechanism in its initial state. Also, many of the actuation approaches that will be presented later will be distinguished as to whether or not they are capable of applying in-plane and out-of-plane forces and moments. The preference for in-plane or out-of-plane actuation will depend on the application.

Throughout chapters four and five the term “LEM(s)” will refer to both single-layer LEMs and multi-layer LEMs unless explicitly stated otherwise. For the purposes of this chapter, the following conventions have been established (see Figure 4.1 for reference):

- Each mechanism will have an overall length, width and height in its initial, flat state.
- The y-direction is parallel to the length, or longest edge, of the mechanism.
- The x-direction is parallel to the width of the mechanism.
- The xy-plane is also known as the fabrication plane. When a single-layer LEM is in its initially flat state, all of its links lie within the xy-plane. When forces or moments are discussed as being “in-plane” or “out-of-plane”, it is in reference to the xy-plane.
- The z-direction is perpendicular to the xy-plane.

In many applications, LEMs will be transported or delivered in their flat, initial state and remain that way until they reach their deployment location. Figure 4.2 shows a LEM in its initially flat state and projections of the area required in each direction for its insertion. It can be seen that insertion in the x-direction (the xz-plane) and the y-direction (the yz-plane) require relatively little

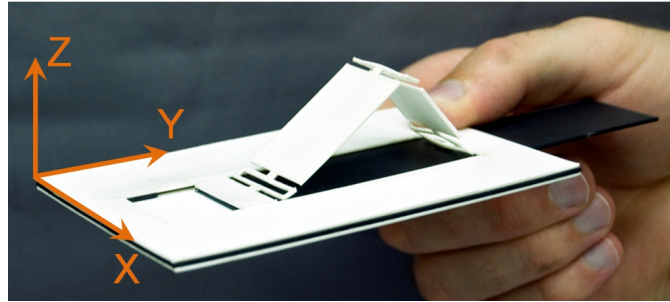

Figure 4.1: MLEM crank-slider with axes defined as shown

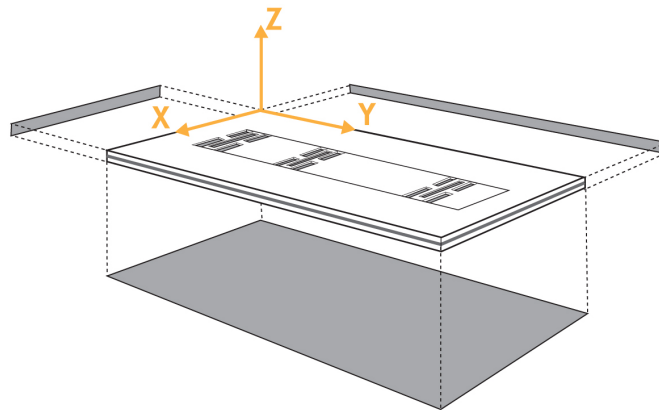

Figure 4.2: An MLEM showing the cross-sectional area required for mechanism insertion in each direction as indicated by the projected shadows

area when compared to insertion in the z-direction (the xy-plane). Regardless of which way the mechanism is inserted to its final destination, there may be space available for actuation in the direction through which the mechanism traveled to arrive at the final location. That space available could be used to accommodate electrical wires, the motion of a slider or other parts required for actuation.

#### 4.1 Out-of-plane Forces and Moments

Out-of-plane forces and moments are consistent with the out-of-plane motion that LEMs achieve. An example, where a flat mechanism is desired and out-of-plane actuation is preferred, is a membrane switch. Membrane switches are made of layers and the buttons are pressed or actuated in a direction perpendicular to the plane of fabrication. An example where out-of-plane

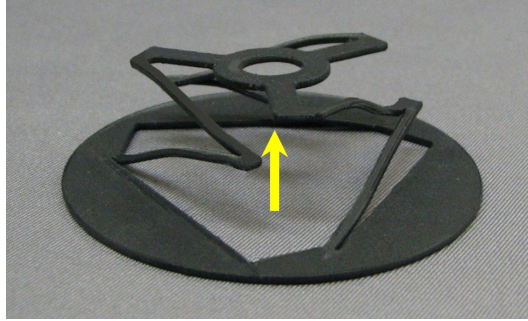

Figure 4.3: A single-layer LEM spring, where the out-of-plane actuation force is indicated by the arrow

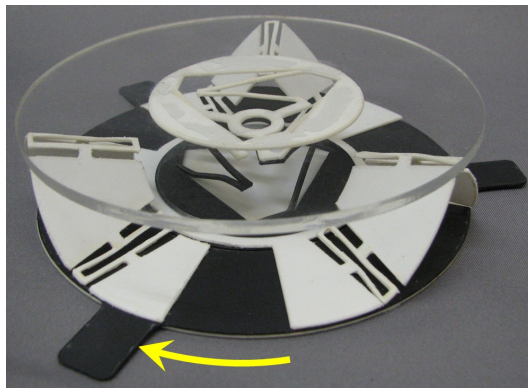

Figure 4.4: A MLEM composed of multiple crank-sliders, a spring, and a platform, where the in-plane actuation moment is indicated by the arrow

actuation is used in LEMs is a linear motion LEM spring [2–4]. Figure 4.3 shows this mechanism in an actuated position where the out-of-plane force is represented by the arrow in the picture. A similar example is in a proposed continuously variable transmission with ortho-planar compliant mechanism [43]. The ortho-planar mechanism in this patent has a design similar to the LEM spring in Figure 4.3. In the above examples, the mechanisms were created using planar layers and are actuated by a forces applied in the  $z$ -direction of the mechanism.

Out-of-plane moments can also be very useful for actuating LEMs. As a mechanism's links move out of the fabrication plane, the links adjacent to the fabrication plane will go through a rotation as they move. A simple example is a single-layer parallel-guiding LEM. Figure 4.5 depicts this mechanism being actuated by an out-of-plane moment (represented by an arrow). While this is a parallel-guided mechanism and one link remains parallel to ground (the fabrication plane), the two links adjacent to ground rotate about their joints connected to ground.



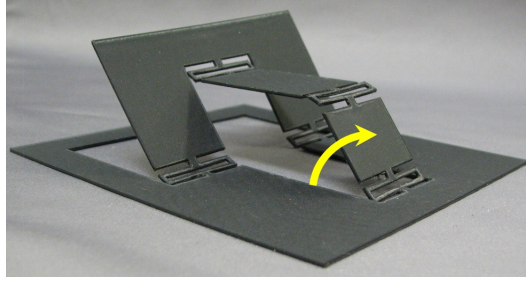

Figure 4.5: A single-layer parallel-guiding LEM, where the out-of-plane actuation moment is indicated by the arrow

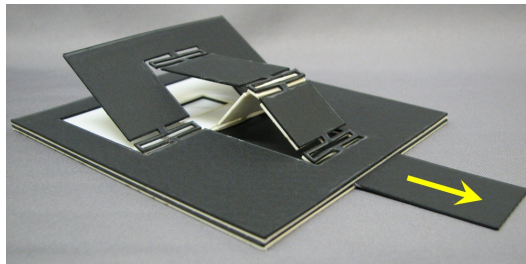

Figure 4.6: A MLEM composed of a crank-slider attached to a parallel-guiding mechanism, where the in-plane actuation force is indicated by the arrow

## 4.2 In-plane Forces and Moments

In-plane actuation can be advantageous in LEMs because it most often involves a simple sliding motion. Figure 4.7 shows a spherical single-layer LEM crank-slider which is actuated by an in-plane moment as indicated by the arrow. The in-plane moment causes the emergent links to move out of the  $xy$ -plane. In single-layer LEMs, both the emergent link(s) of the mechanism and the link(s) that is acted upon for actuation exist in the same layer.

Multi-layer LEMs (MLEMs) can offer more options for actuation because of the possibility of having actuation integrated into a layer separate from the emergent layer(s). Figure 4.8 shows a MLEM crank-slider (white) which is actuated by an in-plane force applied to the actuation layer (black). As the in-plane force is applied, the two links of the MLEM crank-slider are forced out of the  $xy$ -plane.

Multi-layer LEMs can also allow for out-of-plane forces and moments to be achieved with simple in-plane actuation. The crank-slider mechanism is useful in facilitating these out-of-plane forces and moments, as will be demonstrated. The addition of layers in MLEMs allows for more

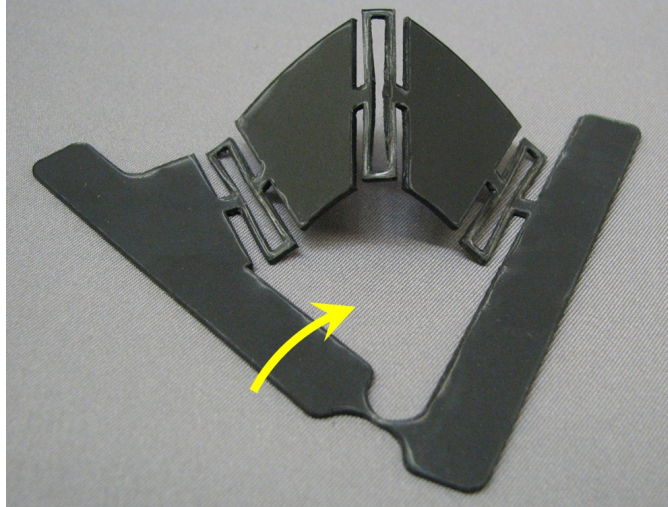

Figure 4.7: A spherical single-layer LEM, where the in-plane actuation moment is indicated by the arrow

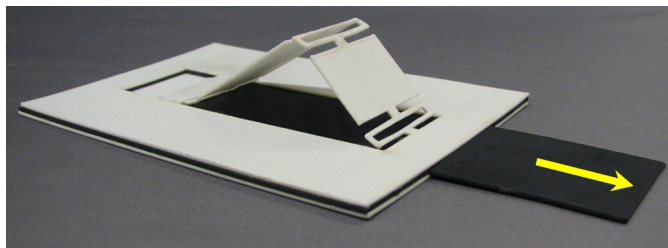

Figure 4.8: A MLEM crank-slider, where the in-plane actuation force is indicated by the arrow

actuation options. For example, when the single-layer parallel-guided LEM presented in Figure 4.5 is in its flat, initial state, it can only be actuated by forces and moments that have out-of-plane components. By adding more layers, the integration of a crank-slider is possible and the same parallel-guided mechanism can be actuated with a simple in-plane force as shown in Figure 4.6. The in-plane force sets the crank-slider in motion, and since the crank-slider is attached to the parallel-guided mechanism, the crank-slider mechanism applies a moment to the parallel-guided mechanism to set it in motion.

Similarly, the single-layer spring presented in Figure 4.3 is actuated by an out-of-plane force. By adding layers to this spring, the resultant MLEM can achieve the same out-of-plane motion with a simple in-plane moment. Figure 4.4 shows a mechanism made of two of these springs in series. This multi-layer spring is attached to the transparent top layer. A series of three

spherical multi-layer LEM crank-sliders are actuated by an in-plane moment. The crank sliders are not attached to the top layer, rather they are allowed to slide against the top layer as they push up on it, applying an out-of-plane force, which moves the spring in the  $z$ -direction.

## **CHAPTER 5. SUITABLE ACTUATION APPROACHES FOR LEMS**

To help in selecting actuators for use with LEMs, it was important to establish criteria that can be used to evaluate which are suitable for use with LEMs. Many actuation techniques were initially considered, but only those that met the suitability criteria are considered in this section. The suitability criteria are 1) the actuator must be viable for use in the macro-scale, 2) the actuator must be consistent with the advantages of LEMs, and 3) the actuator must be able to be incorporated into the design of a LEM. The following three actuation types met the suitability criteria: shape memory alloys, piezoelectrics, and dielectric elastomers. The actuator characteristics that are most useful to LEM design will be analyzed in this section of the paper.

### **5.1 Shape Memory Alloys**

Shape memory alloys (SMAs) can be plastically deformed under stress at a cool temperature. When the SMA is heated above the transition temperature the molecules in the metal rearrange to an austenitic state causing the actuator to return back to its original pre-deformed state [44, 45]. Some common SMAs are nickel-titanium, copper-zinc-aluminium, and copper-aluminium-nickel. SMAs are found in aerospace applications, transportation applications, medical applications, dental applications and in consumer products such as glasses and golf clubs [46].

Due to their properties, SMAs could be an excellent choice for LEM actuation. They have a large range of motion, which can be advantageous for LEM actuation. Hawkes et al. presented “programmable matter”, which is sheet material that is folded 180deg through the use of SMA actuation [47]. SMAs come in many different shapes and sizes. The most useful shapes for LEM applications are sheets and wires, which are commercially available. SMAs are commonly used on the macro scale and there has been work done to show feasibility of their use on the micro scale [48–50]. SMAs are not very precise due to non-linearities and hysteresis in the shape memory effect [51].

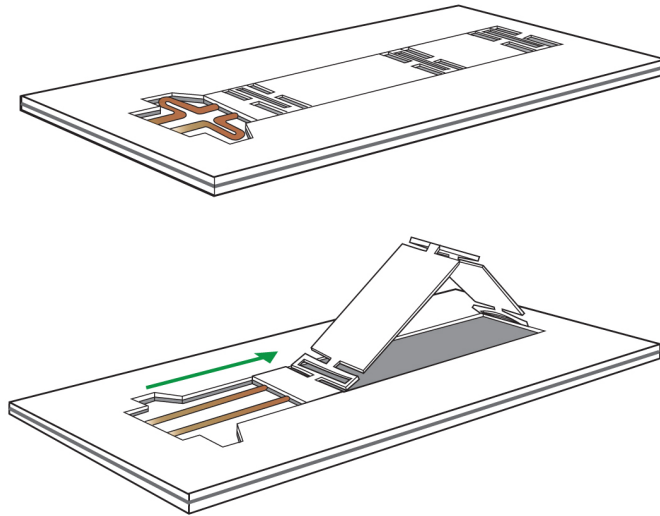

Figure 5.1: SMA wires used to achieve an in-plane force, where the direction of force is indicated by the arrow

SMA actuation layers in LEMs could be made from SMA sheets or wires could be imbedded in or attached to layers of a LEM. Proper preparation of the SMA sheets or wires could allow for both in-plane and out-of-plane forces and moments. Figures 5.1-5.4 show that both in-plane and out-of-plane forces and moments could be attainable in LEMs with the use of SMA actuators. For this discussion, it is assumed that the initial condition of the wires is straight and the initial condition of the sheets is flat. The first image of each figure depicts the SMA actuator incorporated into a LEM in a deformed shape, prior to actuation. Upon heating, the wires and sheets go back to their initial straight or flat condition, as shown in the second image in each figure. The arrows represent the in-plane and out-of-plane moments and forces.

The MigaOne<sup>1</sup>, a commercially available actuator, uses SMA wires to achieve a stroke of .375”, a constant output force of 2.5 lbs., and has dimensions of 2.8” x 1.3” x .098”. The characteristics of this actuator are more than sufficient to actuate a LEM and are consistent with the advantages of LEMs. SMA wires in a configuration similar to this actuator could actuate a LEM or this actuator itself could be used to actuate a LEM.

<sup>1</sup>For more information about this actuator see <http://www.migamotors.com/>

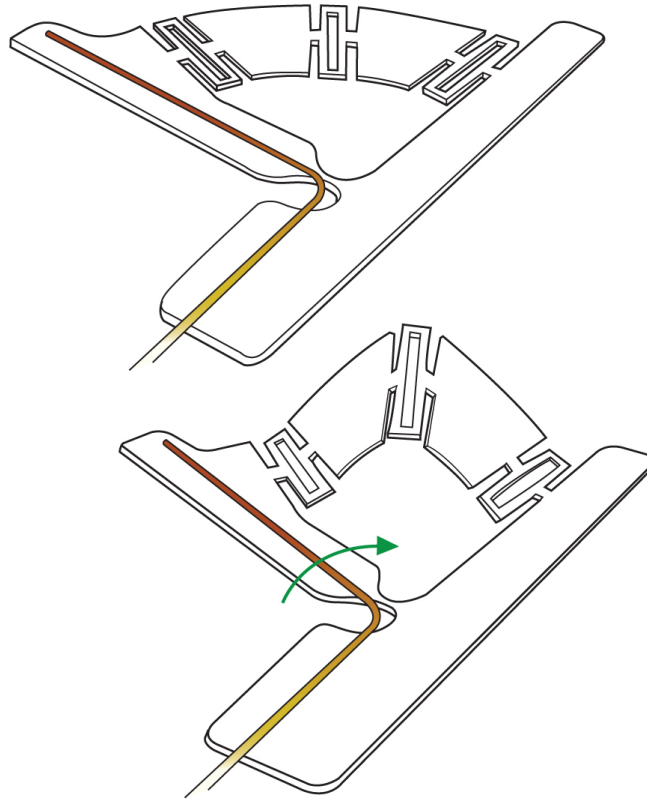

Figure 5.2: A SMA wire used to achieve an in-plane moment, where the direction of the moment is indicated by the arrow

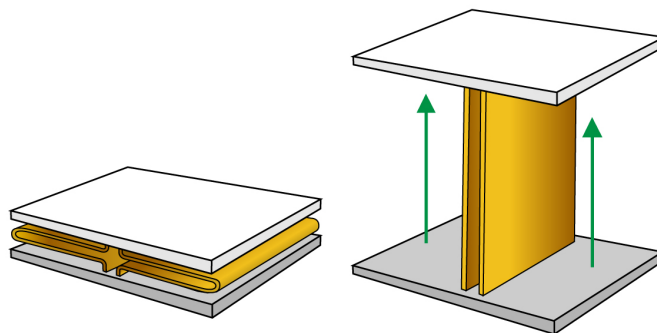

Figure 5.3: SMA sheets used to achieve out-of-plane force, where the direction of force is indicated by the arrow

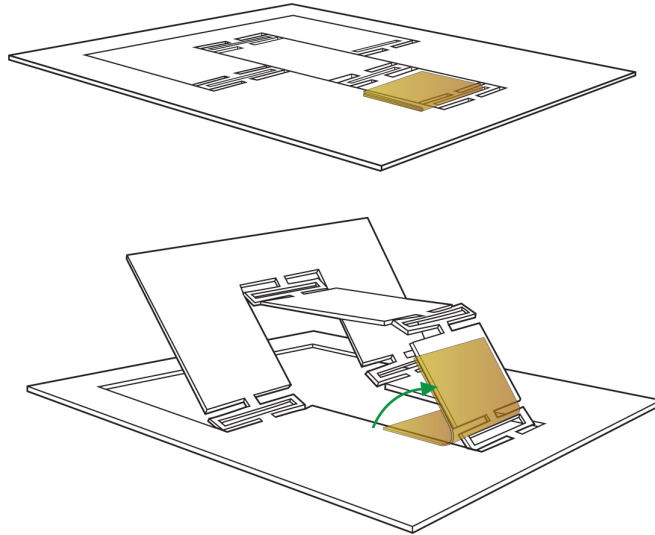

Figure 5.4: A SMA sheet used to achieve an out-of-plane moment, where the direction of the moment is indicated by the arrow

## 5.2 Piezoelectrics

Piezoelectrics are polarized when the material is strained (the direct piezoelectric effect) [52, 53]. Likewise, piezoelectrics become strained in the presence of an electric field (the converse piezoelectric effect) [52, 53]. Some common piezoelectric materials are quartz, Rochelle salt, lead zirconate titanate (PZT), barium titanate ( $\text{BaTiO}_3$ ), and polyvinylidene flouride (PVDF). The phenomenon of their shape change occurs because of the kind of molecules that make up a piezoelectric material. Piezoelectric materials are frequently used as sensors because of their precision in detecting small forces and electric potentials. Piezoelectrics are commonly used as actuators due to the fact that the material can expand or contract depending on the direction of the electric field [54].

Piezoelectrics have large output forces, are very precise in their motion, and can be actuated at high frequencies. Piezoelectrics are often made in single or multiple planar layers, making the geometric aspect of them compatible for use with LEMs. There are two main ways that piezoelectrics are used in actuation: 1) a piezoelectric stack and 2) a multi-layer cantilever beam configuration. This cantilever beam configuration is referred as a “biomorph structure composed of two TE mode layers” [55]. Cantilever beam-type piezoelectric actuators are commercially avail-

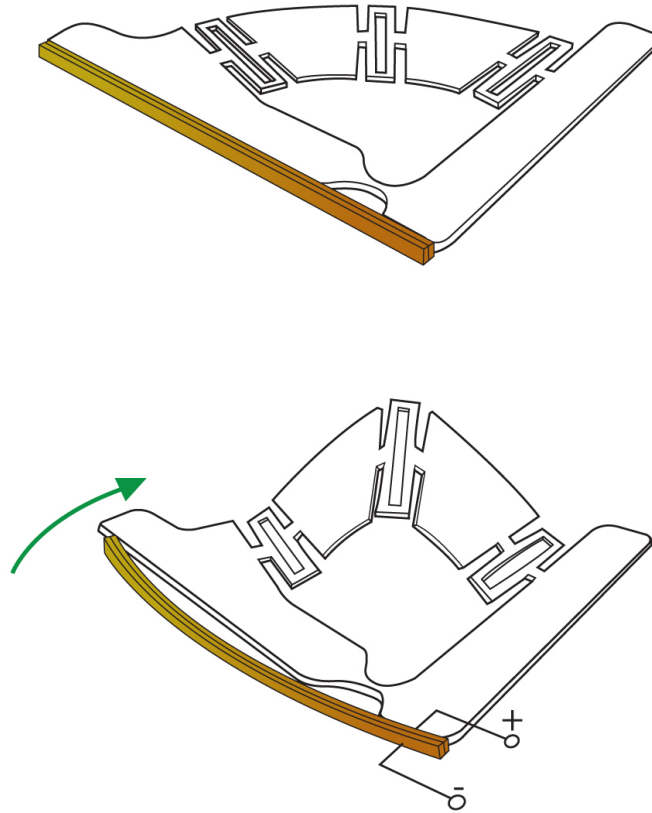

Figure 5.5: A piezoelectric actuator used to achieve an in-plane moment, where the direction of the moment is indicated by the arrow

able. Johnson Matthey sells a Piezo Bending Actuator<sup>2</sup>. These commercially available actuators are flat, thin and can achieve deflections large enough to actuate LEMs. Figure 5.5 shows how a piezoelectric cantilever beam could be used in this way to actuate a LEM. In addition to using this cantilever beam configuration to achieve in-plane forces and moments, it may also be a feasible way of attaining out-of-plane forces and moments.

### 5.3 Dielectric Elastomers

Dielectric elastomers are composed of an elastomeric film that is sandwiched between two compliant electrodes. When subjected to an electric field, the electrodes attract, which squishes the elastomeric film and causes it to expand in the x and y directions and contract in the z direction

<sup>2</sup>For more information about this actuator see <http://www.piezoproducts.com/en/>



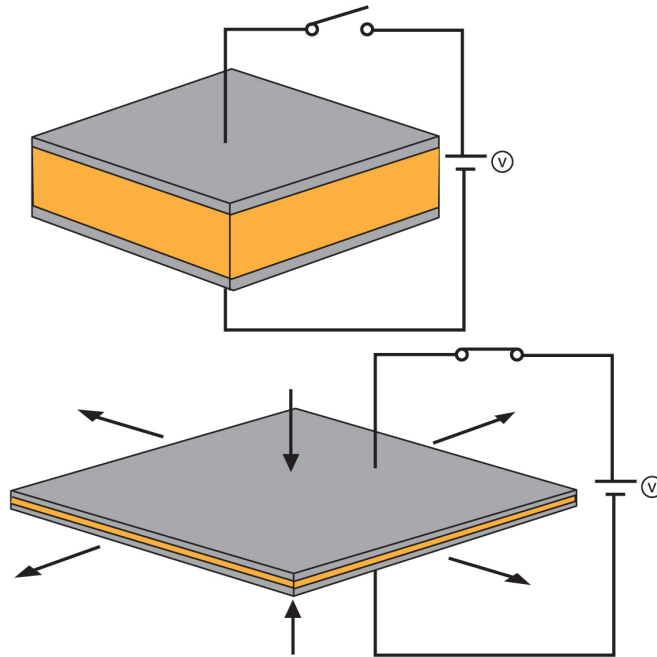

Figure 5.6: The upper image shows a in its initial condition with no applied electric field. The lower image shows it in its deformed condition as a result of an applied electric field.

(see Figure 5.6). This can result in strains of well over 100% [56–59]. Strains of this magnitude are more than sufficient for LEM actuation.

Dielectric elastomer films are usually made of silicone or acrylic material. Usually these actuators are planar in shape, making their form factor appealing for use with LEMs. Dielectric elastomers are capable of fast response times, high strains, good actuation pressures, and high specific energy densities [60]. One of the challenges of dielectric elastomers is that they are not very precise. This is due to the viscoelasticity of the materials, creep and stress relaxation [61]. In-plane forces are attainable with dielectric elastomers. Figure 5.7 shows a how a dielectric elastomer could be used as a LEM actuator applying an in-plane force. In terms of LEM actuation, these materials are best suited for applying in-plane forces.

#### 5.4 Summary of the Characteristics of Suitable LEM Actuators

Ultimately the type of actuation chosen to activate a LEM is a decision that must be made by the designer. Different characteristics specific to the LEM will play into this decision such as: the size of the LEM, the amount of space available around the LEM, the force required to actuate

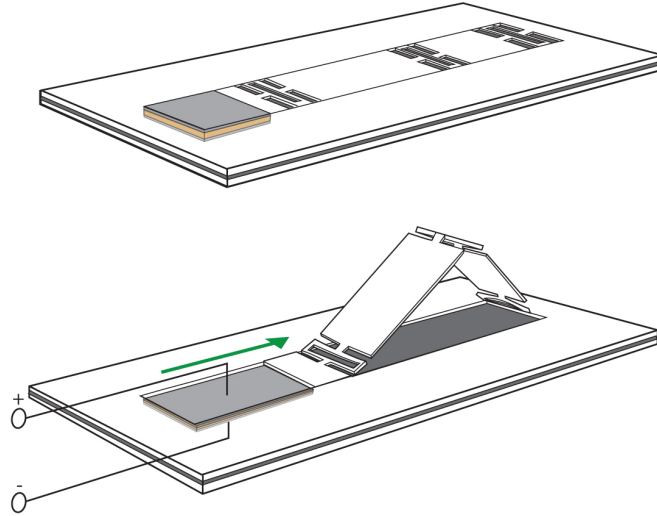

Figure 5.7: A dielectric elastomer used to achieve an in-plane force, where the direction of the force is indicated by the arrow

Table 5.1: Characteristics of three actuators suitable for use with LEMs

Actuator	Actuation trigger	Common materials	Compatible form factors	Precision	Ways to move LEMs
Shape Memory Alloys	Thermal	Ni-Ti Cu-Zn-Al Cu-Al-Ni	Sheet Wire	Low	In-plane: forces & moments Out-of-plane: forces & moments
Piezoelectrics	Electrical	Quartz Rochelle salt BaTiO <sub>3</sub> PZT PVDF	Sheet	High	In-plane: forces & moments Out-of-plane: forces & moments
Dielectric Elastomers	Electrical	Silicones Acrylics	Sheet	Low	In-plane: forces

the LEM, the force required to interact with the LEM's surroundings, the maximum deflection of the LEM, the material(s) from which the LEM is made and the thickness of the layer(s). Characteristics specific to the actuator must also be taken into account such as: what triggers the actuation, the material from which the actuator is made, actuator form factors compatible with LEMs, the precision of the actuator, and the type of forces and moments achievable with the actuator. Table 5.1 summarizes the actuator-specific characteristics of the chosen actuators suitable for use with

LEMs. This table may be useful for reference to designers when trying to decide the best type of LEM actuation to use with a specific design.

## CHAPTER 6. CONCLUSIONS AND RECOMMENDATIONS

### 6.1 Conclusions

MLEMs can be used advantageously in a variety of applications that benefit from their characteristics and can achieve complex motions not traditionally associated with planar mechanisms. MLEMs accomplish this with a simple topology, low manufacturing cost and a flat initial state. MLEMs can potentially be used in a variety of energy transfer applications such as mechanical, heat, electrical, chemical, and light energy transfer. MLEMs can also potentially be used to transform energy from one form to another.

There are a number of ways in which the additional layers of MLEMs allow for enhanced capabilities compared to single-layer mechanisms. Each layer adds to the amount of usable area from which a mechanism can be created. With more layers a mechanism can achieve increased deflection with the same footprint at the same stress. In multiple layers, the same motion can be achieved as with a single layer, but with a reduced mechanism footprint. MLEMs also allow for more options for actuation. Contact-aided interactions between layers further enhance the capabilities of MLEMs. Metamorphosis is more easily achieved with multiple layers and thus bistability is also facilitated in MLEMs. Multiple layers can also bias the motion of MLEMs as well as give additional resistance to the mechanism.

Layer separation is one application for which multi-layer LEMs are well-suited. Three different mechanism configurations were presented to illustrate the diversity of ways to achieve this motion with MLEMs. Layer separation can be applied to a number of different applications such as impact absorption, energy storage, heat transfer control, electrical contacts or switches, and different types of energy transformation.

LEMs and MLEMs demand actuation methods that are consistent with the advantages of these mechanisms and can be incorporated into their design. While this eliminates some of the more traditional actuators such as motors, pneumatics and hydraulics, there exist other actuation

approaches which may be well-suited for LEMs and MLEM. Shape memory alloys, piezoelectrics and dielectric elastomers are among these actuation approaches that are well-suited for use as LEM and MLEM actuators. Each of these actuators can be triggered by common methods, comes in sheet form, can be made from common materials, and can achieve forces and/or torques in directions that can set LEMs and MLEM into motion.

The design of the LEM or MLEM may influence which actuation method is best-suited for it. Other unique characteristics of each actuator could also factor into the actuator selection process. The application for which the LEM or MLEM is being designed may also impact this choice. Ultimately it is up to the designer to decide which actuator is best for his/her design.

A number of novel MLEMs are presented throughout this thesis (see Appendix A).

## 6.2 Recommendations

This thesis has introduced multiple-layer lamina emergent mechanisms as a new class of mechanisms with many advantages and has introduced actuation approaches suitable for LEMs and MLEM. Throughout the course of this work, many other areas have been identified for the continued development of LEMs and MLEM. Some of these areas are included in following list and are recommended for future work:

- It was found that other researchers have used geometries very similar to that of the LET joint for actuation [47, 62, 63]. It is recommended that these actuation techniques be investigated further as potential ways of incorporating actuation into LET joints in LEMs and MLEM. Actuation built into the joints of LEMs and MLEM could be a good way of creating motion in these mechanisms.
- During the study of in-plane compliant mechanisms, it was found that many of the in-plane CMs that have been developed by other researchers are bistable [31, 32, 34]. It is recommended that bistable in-plane compliant mechanisms be investigated further for use as a layer, or layers, in MLEM as another way of creating bistable MLEM.
- The study of shape memory alloys in conjunction with the development of MLEM led to the idea that an entire layer of an MLEM could be made of a SMA sheet, or in a single-layer

LEM the entire mechanism itself could be a SMA sheet. It is recommended that further investigation be done into having the actuator, itself, be the entire mechanism through the use of SMA sheets.

- Chapter 2 of this work looks at different ways in which layered systems transfer and transform energy. Chapter 2 also suggests ways that MLEMs could also be used to achieve energy transfer and transformation. It is recommended that this be investigated further and, with further development, that physical prototypes be made.
- Chapter 5 of this work presented suitable actuation approaches for LEMs and MLEMs. It is recommended that these actuation techniques be investigated further and be incorporated into physical prototypes to actuate LEMs and MLEMs.
- Finally, it is recommended that more work be done to investigate making LEM and MLEM arrays. LEMs and MLEMs are made from sheet materials. There are many low-cost manufacturing processes that can process sheet materials and can easily make arrays. With actuation approaches identified for use with LEMs and MLEMs, and upon building physical prototypes that use these actuators, it will be possible to create arrays that can be actuated simultaneously or can use indexing to actuated individual mechanisms.



## REFERENCES

- [1] Jacobsen, J. O., Winder, B. G., Howell, L. L., and Magleby, S. P., 2010. “Lamina emergent mechanisms and their basic elements.” *Journal of Mechanisms and Robotics*, **2**(1), pp. 011003–011009.
- [2] Parise, J. J., Howell, L. L., and Magleby, S. P., 2001. “Ortho-planar linear-motion springs.” *Mechanism and Machine Theory*, **36**(11-12), pp. 1281–1299.
- [3] Anderson, S., and Jensen, B. D., 2008. “Viscoelastic damping of Ortho-Planar springs.” *ASME Conference Proceedings*, **2008**(43260), pp. 323–330.
- [4] Howell, L. L., Thomson, S., Briscoe, J. A., Parise, J. J., Lorenc, S., Larsen, J. B., Huffmire, C. R., Burnside, N., and Gomm, T. A., 2006. United states patent: 6983924 - compliant, ortho-planar, linear motion spring.
- [5] Howell, L. L., 2001. *Compliant mechanisms*. Wiley.
- [6] Ananthasuresh, G., and Kota, S., 1995. “Designing compliant mechanisms.” *Mechanical Engineering*, **117**(11), pp. 93–96.
- [7] Albrechtsen, N. B., Magleby, S. P., and Howell, L. L., 2010. “Identifying potential applications for lamina emergent mechanisms using technology push product development.” In *Proceedings of ASME 2010 Design Engineering Technical Conferences, DETC2010-28531*.
- [8] Parise, J. J., Howell, L. L., and Magleby, S. P., 2000. “Ortho-planar mechanisms.” In *Proceedings of the 2000 ASME Design Engineering Technical Conferences, DETC2000/MECH-14193*.
- [9] Jacobsen, J. O., Chen, G., Howell, L. L., and Magleby, S. P., 2009. “Lamina emergent torsional (LET) joint.” *Mechanism and Machine Theory*, **44**(11), pp. 2098–2109.
- [10] Winder, B. G., Magleby, S. P., and Howell, L. L., 2008. “A study of joints suitable for lamina emergent mechanisms.” In *Proceedings of ASME 2008 Design Engineering Technical Conferences, DETC2008-49914*.
- [11] Ferrell, D. B., 2010. “Development of criteria for lamina emergent mechanism flexures with specific application to metals.” Master’s thesis, Brigham Young University.
- [12] Dai, J. S., and Jones, J. R., 2005. “Matrix representation of topological changes in metamorphic mechanisms.” *Journal of Mechanical Design, Transactions of the ASME*, **127**(4), pp. 837–840.
- [13] Liu, H., and Dai, J., 2002. “Carton manipulation analysis using configuration transformation.” *Journal of Mechanical Engineering Science*, **216**(5), pp. 543–555.



- [14] Dai, J., and Jones, J. R., 1999. “Mobility in metamorphic mechanisms of foldable/erectable kinds.” *Journal of Mechanical Design, Transactions of the ASME*, **121**(3), pp. 375–382.
- [15] Carroll, D. W., Magleby, S. P., Howell, L. L., Todd, R. H., and Lusk, C. P., 2005. “Simplified manufacturing through a metamorphic process for compliant ortho-planar mechanisms.” *American Society of Mechanical Engineers, Design Engineering Division (Publication) DE*, **118 A**(1), pp. 389–399.
- [16] Jackson, P., and Forrester, P., 1993. *The pop-up book: step-by-step instructions for creating over 100 original paper projects*. Henry Holt and Company, LLC, New York.
- [17] Winder, B. G., Magleby, S. P., and Howell, L. L., 2009. “Kinematic representations of pop-up paper mechanisms.” *Journal of Mechanisms and Robotics*, **1**, pp. 1–10.
- [18] Mankame, N. D., and Ananthasuresh, G., 2007. “Synthesis of contact-aided compliant mechanisms for non-smooth path generation.” *International Journal for Numerical Methods in Engineering*, **69**(12), pp. 2564–2605.
- [19] Mankame, N. D., and Ananthasuresh, G., 2002. “Contact aided compliant mechanisms: Concept and preliminaries.” In *Proceedings of the 2002 ASME Design Engineering Technical Conferences, DETC2002/MECH-34211*.
- [20] Mankame, N. D., and Ananthasuresh, G., 2004. “A novel compliant mechanism for converting reciprocating translation into enclosing curved paths.” *Journal of Mechanical Design, Transactions of the ASME*, **126**(4), pp. 667–672.
- [21] Mankame, N. D., and Ananthasuresh, G., 2004. “Topology optimization for synthesis of contact-aided compliant mechanisms using regularized contact modeling.” *Computers and Structures*, **82**(15-16), pp. 1267–1290.
- [22] Cannon, J. R., and Howell, L. L., 2005. “A compliant contact-aided revolute joint.” *Mechanism and Machine Theory*, **40**(11), pp. 1273–1293.
- [23] Yulin, M., and Xiaoming, W., 2004. “A level set method for structural topology optimization and its applications.” *Advances in Engineering Software*, **35**(7), pp. 415–441.
- [24] Wang, M. Y., Chen, S., Wang, X., and Mei, Y., 2005. “Design of multimaterial compliant mechanisms using level-set methods.” *Journal of Mechanical Design, Transactions of the ASME*, **127**(5), pp. 941–956.
- [25] Yin, L., and Ananthasuresh, G., 2001. “Topology optimization of compliant mechanisms with multiple materials using a peak function material interpolation scheme.” *Structural and Multidisciplinary Optimization*, **23**(1), pp. 49–62.
- [26] Sigmund, O., 2001. “Design of multiphysics actuators using topology optimization - part II: two-material structures.” *Computer Methods in Applied Mechanics and Engineering*, **190**(49-50), pp. 6605–6627.
- [27] Zhou, H., and Ting, K.-L., 2007. “Geometric modeling and optimization of multi-material compliant mechanisms using multi-layer wide curves.” In *Proceedings of the ASME International Mechanical Engineering Congress and Exposition, IMECE 2007*, pp. 55–64.

- [28] Gouker, R. M., Gupta, S. K., Bruck, H. A., and Holzschuh, T., 2006. “Manufacturing of multi-material compliant mechanisms using multi-material molding.” *International Journal of Advanced Manufacturing Technology*, **30**(11-12), pp. 1049–1075.
- [29] Mackay, A., 2007. “Large-displacement linear-motion compliant mechanisms.” Master’s thesis, Brigham Young University.
- [30] Hubbard, N. B., Wittwer, J. W., Kennedy, J. A., Wilcox, D. L., and Howell, L. L., 2004. “A novel fully compliant planar Linear-Motion mechanism.” *ASME Conference Proceedings*, **2004**(46954), pp. 1–5.
- [31] Wilcox, D., and Howell, L., 2005. “Fully compliant tensural bistable micromechanisms (FTBM).” *Journal of Microelectromechanical Systems*, **14**(6), pp. 1223–1235.
- [32] Gomm, T., Howell, L. L., and Selfridge, R. H., 2002. “In-plane linear displacement bistable microrelay.” *Journal of Micromechanics and Microengineering*, **12**, pp. 257–264.
- [33] Choi, K., and Kim, D., 2006. “Monolithic parallel linear compliant mechanism for two axes ultraprecision linear motion.” *Review of Scientific Instruments*, **77**(6), p. 065106.
- [34] Baker, M., and Howell, L., 2002. “On-chip actuation of an in-plane compliant bistable micromechanism.” *Journal of Microelectromechanical Systems*, **11**(5), pp. 566–573.
- [35] Jensen, B. D., Howell, L. L., and Salmon, L. G., 1999. “Design of Two-Link, In-Plane, bistable compliant Micro-Mechanisms.” *Journal of Mechanical Design*, **121**(3), pp. 416–423.
- [36] Kovacs, G., Maluf, N., and Petersen, K., 1998. “Bulk micromachining of silicon.” *Proceedings of the IEEE*, **86**(8), pp. 1536–1551.
- [37] Bustillo, J., Howe, R., and Muller, R., 1998. “Surface micromachining for microelectromechanical systems.” *Proceedings of the IEEE*, **86**(8), pp. 1552–1574.
- [38] Fan, L., Tai, Y., and Muller, R. S., 1989. “IC-processed electrostatic micromotors.” *Sensors and Actuators*, **20**(1-2), pp. 41–47.
- [39] Yang, X., Grosjean, C., and Tai, Y., 1999. “Design, fabrication, and testing of micromachined silicone rubber membrane valves.” *Journal of Microelectromechanical Systems*, **8**(4), pp. 393–402.
- [40] Niarchos, D., 2003. “Magnetic MEMS: key issues and some applications.” *Sensors and Actuators*, **106**(1-3), pp. 255–262.
- [41] DeVoe, D., and Pisano, A., 1997. “Modeling and optimal design of piezoelectric cantilever microactuators.” *Journal of Microelectromechanical Systems*, **6**(3), pp. 266–270.
- [42] Weinberg, M., 1999. “Working equations for piezoelectric actuators and sensors.” *Journal of Microelectromechanical Systems*, **8**(4), pp. 529–533.
- [43] Whiting, M. J., Howell, L. L., Todd, R. H., Magleby, S. P., Anderson, M. C., and Rasmussen, N. O., 2008. United states patent: 7338398 - continuously variable transmission or clutch with ortho-planar compliant mechanism.

- [44] Pelton, A. R., and Duerig, T. W., 2004. *SMST-2003: proceedings of the International Conference on Shape Memory and Superelastic Technologies, 5 May to 8 May 2003, Asilomar Conference Center, Pacific Grove, California, USA*. ASM International.
- [45] Duerig, T. W., Melton, K. N., Stockel, D., and Wayman, C. M., 1990. *Engineering Aspects of Shape Memory Alloys*. Butterworth-Heinemann.
- [46] Lagoudas, D. C., 2008. *Shape memory alloys modeling and engineering applications*. Springer.
- [47] Hawkes, E., An, B., Benbernou, N. M., Tanaka, H., Kim, S., Demaine, E. D., Rus, D., and Wood, R. J., 2010. “Programmable matter by folding.” *Proceedings of the National Academy of Sciences*, **107**(28), pp. 12441–12445.
- [48] Kahn, H., Huff, M. A., and Heuer, A. H., 1998. “The TiNi shape-memory alloy and its applications for MEMS.” *Journal of Micromechanics and Microengineering*, **8**, pp. 213–221.
- [49] Fu, Y., Huang, W., Du, H., Huang, X., Tan, J., and Gao, X., 2001. “Characterization of TiNi shape-memory alloy thin films for MEMS applications.” *Surface and Coatings Technology*, **145**(1-3), pp. 107–112.
- [50] Roch, I., Bidaud, P., Collard, D., and Buchaillet, L., 2003. “Fabrication and characterization of an SU-8 gripper actuated by a shape memory alloy thin film.” *Journal of Micromechanics and Microengineering*, **13**(2), pp. 330–336.
- [51] Madill, D., and Wang, D., 1998. “Modeling and l2-stability of a shape memory alloy position control system.” *Control Systems Technology, IEEE Transactions on*, **6**(4), pp. 473–481.
- [52] Ikeda, T., 1990. *Fundamentals of piezoelectricity*. Oxford University Press.
- [53] Cady, W. G., 1964. *Piezoelectricity: an introduction to the theory and applications of electromechanical phenomena in crystals*. Dover Publications.
- [54] Uchino, K., 1997. *Piezoelectric actuators and ultrasonic motors*. Springer.
- [55] Tabib-Azar, M., 1998. *Microactuators: electrical, magnetic, thermal, optical, mechanical, chemical & smart structures*. Springer.
- [56] Pelrine, R., Kornbluh, R., Pei, Q., and Joseph, J., 2000. “High-Speed electrically actuated elastomers with strain greater than 100%.” *Science*, **287**(5454), pp. 836–839.
- [57] Kofod, G., Sommer-Larsen, P., Kornbluh, R., and Pelrine, R., 2003. “Actuation response of polyacrylate dielectric elastomers.” *Journal of Intelligent Material Systems and Structures*, **14**(12), pp. 787–793.
- [58] Brochu, P., and Pei, Q., 2010. “Advances in dielectric elastomers for actuators and artificial muscles.” *Macromolecular Rapid Communications*, **31**(1), pp. 10–36.
- [59] Liu, Y., Liu, L., Zhang, Z., and Leng, J., 2009. “Dielectric elastomer film actuators: characterization, experiment and analysis.” *Smart Materials and Structures*, **18**(9), p. 095024.

- [60] Pelrine, R., Kornbluh, R., and Joseph, J., 1998. “Electrostriction of polymer dielectrics with compliant electrodes as a means of actuation.” *Sensors and Actuators*, **64**(1), pp. 77–85.
- [61] Biddiss, E., and Chau, T., 2008. “Dielectric elastomers as actuators for upper limb prosthetics: Challenges and opportunities.” *Medical Engineering & Physics*, **30**(4), May, pp. 403–418.
- [62] Muraoka, M., and Sanada, S., 2010. “Displacement amplifier for piezoelectric actuator based on honeycomb link mechanism.” *Sensors and Actuators*, **157**(1), pp. 84–90.
- [63] Lee, S., Kim, K., and Park, I., 2007. “Modeling and experiment of a muscle-like linear actuator using an ionic polymer metal composite and its actuation characteristics.” *Smart Materials & Structures*, **16**(3), pp. 583–588.



**APPENDIX A. NOVEL MECHANISMS PRESENTED IN THIS WORK**

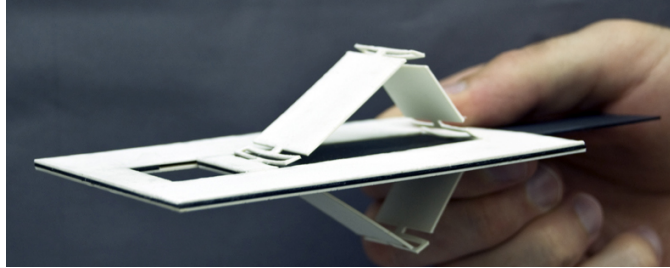

Figure A.1: Mirrored, three-layer crank-slider MLEM

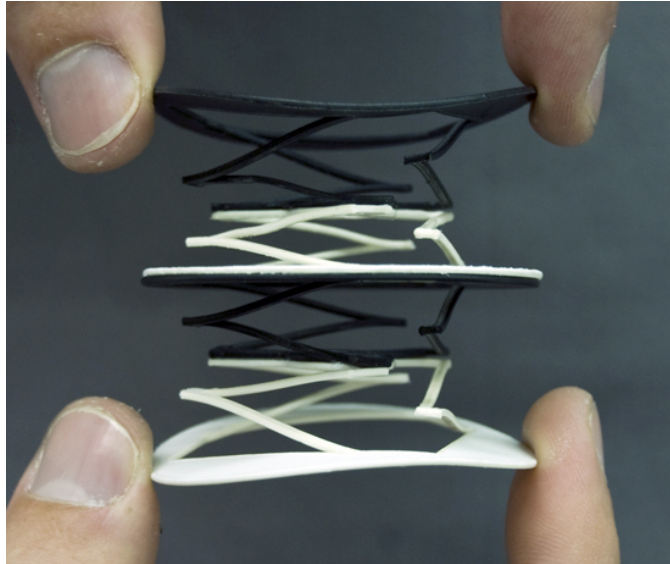

Figure A.2: Four-layer linear spring, increased deflection

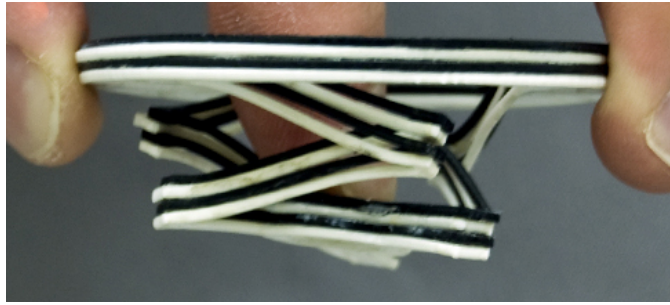

Figure A.3: Four-layer linear spring, increased resistance



Figure A.4: Three-layer contact-aided MLEM

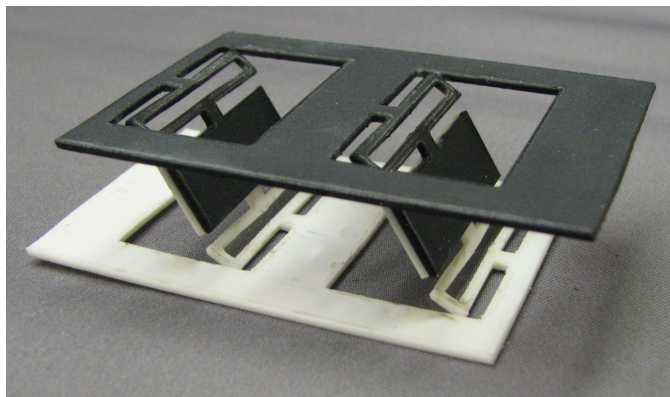

Figure A.5: Two-layer parallel-guiding MLEM

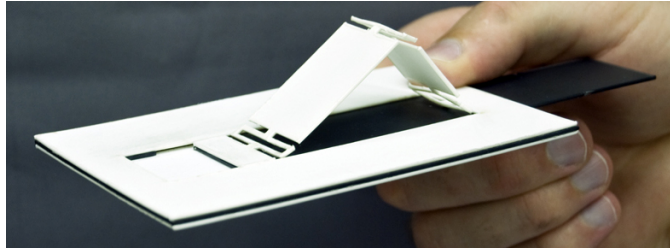

Figure A.6: Three-layer crank slider MLEM

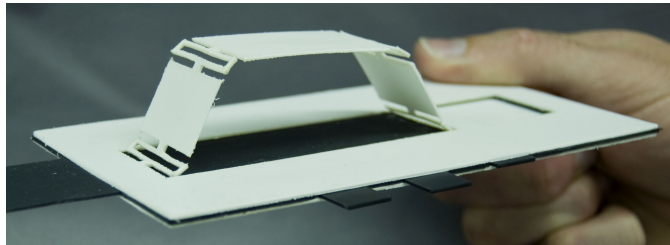

Figure A.7: Metamorphic MLEM

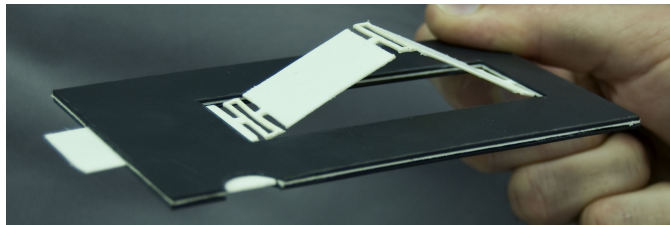

Figure A.8: Metamorphic, bistable MLEM



Figure A.9: MLEM Nuremberg scissor mechanism



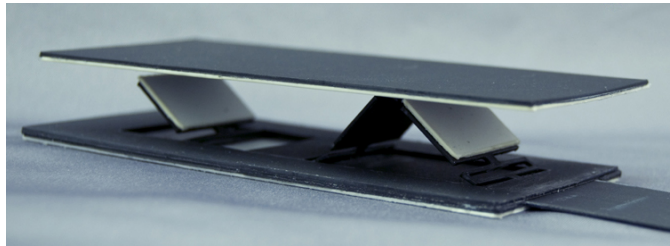

Figure A.10: Crank-slider and parallel-guiding MLEM

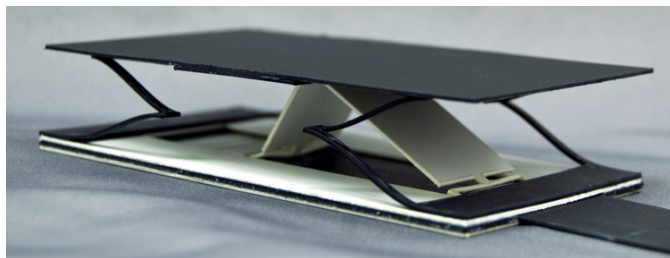

Figure A.11: MLEM crank-slider and platform

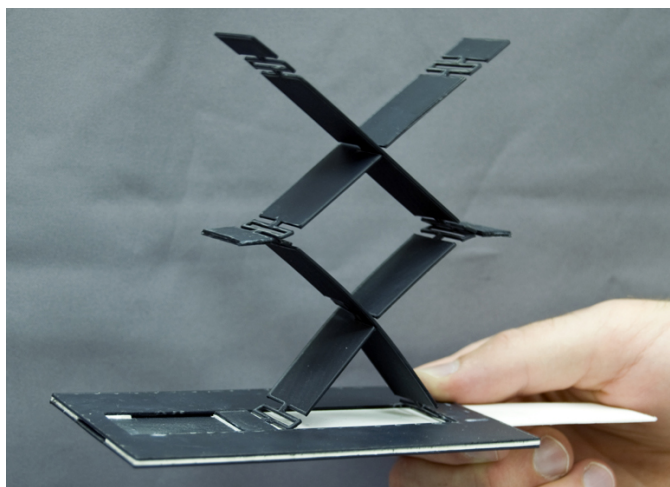

Figure A.12: Nuremberg scissor MLEM repeated

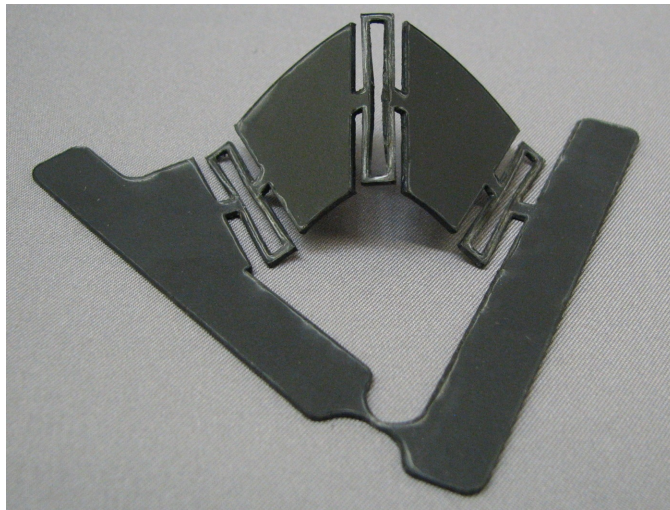

Figure A.13: Spherical single-layer LEM

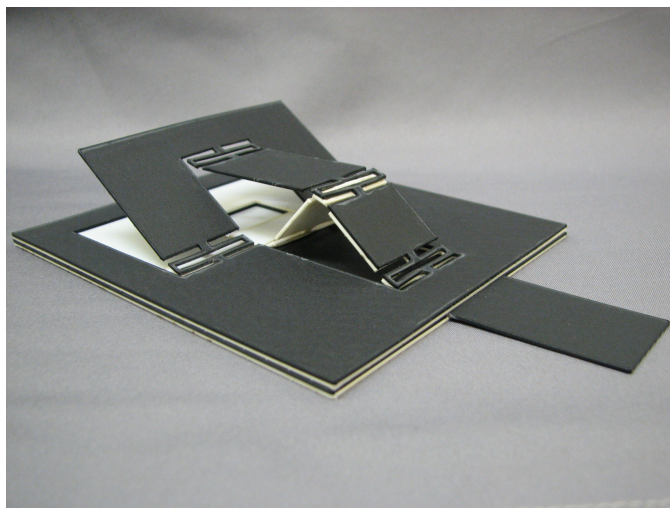

Figure A.14: MLEM, parallel-guiding and crank-slider mechanism

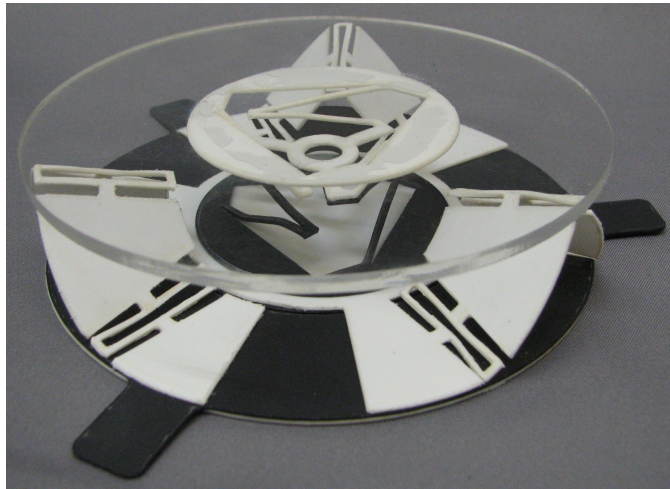

Figure A.15: MLEM composed of multiple crank-sliders, a spring, and a platform